

FM 10-7

DEPARTMENT OF THE ARMY FIELD MANUAL

*Revised by DA Form 311-32
3 May 65*

QUARTERMASTER ORGANIZATION AND OPERATIONS IN DIVISIONS

PROPERTY OF
QUARTERMASTER LIBRARY
QUARTERMASTER SCHOOL, U. S. ARMY
FORT LEONARD WOOD, MISSOURI

FORNICATION LIBRARY FOR 2000

LOGISTICS LIBRARY 12110



HEADQUARTERS, DEPARTMENT OF THE ARMY
NOVEMBER 1958

FIELD MANUAL } HEADQUARTERS,
 No. 10-7 } DEPARTMENT OF THE ARMY
 WASHINGTON 25, D. C., 12 November 1958

QUARTERMASTER ORGANIZATION AND OPERATIONS IN DIVISIONS

	Paragraph	Page
CHAPTER 1. INTRODUCTION	1-3	3
2. CONCEPT OF QUARTER- MASTER OPERATIONS		
Section I. The infantry division.....	4-7	5
II. The armored division.....	8-11	16
III. The airborne division.....	12-16	27
CHAPTER 3. LOGISTICS—SUPPLY		
Section I. General	17-20	38
II. Division distributing point re- quirements	21, 22	43
III. Security	23-27	45
CHAPTER 4. CLASS I SUPPLY OPERA- TIONS		
Section I. Supply requirements	28-32	47
II. Supply administration	33-36	50
III. Requisitioning	37-40	57
IV. Distribution	41-43	60
V. Apportioning bulk supplies....	44-46	64
VI. Breakdown and issue.....	47-49	66
CHAPTER 5. CLASS II AND IV SUPPLY OPERATIONS		
Section I. General	50-52	72
II. Requisitioning procedures	53-55	77
III. Distribution	56-58	88

* This manual supersedes FM 10-7, 10 October 1951.

	Paragraphs	Page
CHAPTER 6. CLASS III SUPPLY OPERATIONS		
Section I. General characteristics -----	59, 60	90
II. Supply requirements -----	61-63	91
III. Requisition -----	64, 65	92
IV. Distribution -----	66-68	95
V. Class III distributing point---	69, 70	98
CHAPTER 7. CLASS V SUPPLY OPERATIONS	71-73	102
8. SERVICE OPERATIONS		
Section I. Bath -----	74-76	104
II. Graves registration -----	77-86	105
III. Salvage, maintenance, and captured materiel -----	87-89	111
IV. Miscellaneous services -----	90-92	114
APPENDIX I. REFERENCES -----		117
II. OPERATIONS UNDER UNUSUAL CONDITIONS -----		123
INDEX -----		132

CHAPTER 1

INTRODUCTION

1. Purpose and Scope

a. This manual discusses organization for quartermaster supply and service in divisions and explains how organic quartermaster units normally provide supply and service support. It is intended as a guide for the employment of quartermaster troops in divisions.

b. This manual is applicable to the—

- (1) Infantry Division Quartermaster Company (TOE 10-17).
- (2) Armored Division Quartermaster Battalion (TOE 10-45).
- (3) Airborne Division Supply and Transportation Company (TOE 29-57) and Airborne Division Quartermaster Parachute Supply Company (TOE 10-337).

2. Modifications

a. This manual reflects policy, doctrine, and procedures current to June 1958. Policies are subject to modification which will result in the publication of changes. Users of this manual are requested to submit recommendations for changes or corrections direct to the Commanding General, the Quartermaster Training Command, Fort Lee, Va. For format and guidance in preparation of recommended changes, see AR 310-3.

b. The material presented herein is applicable without modification to nuclear warfare.

3. Forms

All forms used for quartermaster supply and service operations in divisions will be prescribed by higher headquarters. Standard forms indexed in DA Pam 310-2 will be used as directed, when applicable. Specific forms in normal use at division level are referenced in this manual.

CHAPTER 2

CONCEPT OF QUARTERMASTER OPERATIONS

Section I. THE INFANTRY DIVISION

4. General

The infantry division is the basic organization of combined arms in the field forces. It is the smallest unit of all the essential arms and services that can conduct independent ground operations of general importance. It can strike, penetrate, maneuver readily over all types of terrain, and absorb reinforcing units easily. It can act alone or in concert with other forces. The combat value of the infantry division is in its ability to combine the action of the several arms and services in sustained operations.

5. Organization for Combat

For combat, the division commander organizes his forces to accomplish the specific mission assigned. The infantry battle groups, armored battalion, armored cavalry squadron, and division artillery which comprise the basic combat elements may be combined in any way to form a combat force fitted to the immediate requirements.

a. Command Posts. To maintain effective command and control, the division commander normally establishes—

- (1) A main command post as the principal location from which he exercises command;
- (2) A division rear command post which serves as headquarters for administrative support of the division. Any or all of the special staff may operate from the main command post if the division commander desires.

b. Division Trains.

- (1) Division trains is a tactical command responsible for—
 - (a) Security and defense of the division rear command post and units and installations in the division service area.
 - (b) Organization of division trains for movement and disposition in accordance with tactical plans.
- (2) The infantry division quartermaster is tactically responsible to the division trains commander.

6. Infantry Division Quartermaster Company

The Infantry Division Quartermaster Company (TOE 10-17) provides the division with all classes of quartermaster supply, bath facilities, and graves registration service. It supervises post exchange facilities and directs quartermaster salvage operations. It also provides for direct support of divisional units in maintenance of quartermaster field cooking, heating, and lighting equipment and office machines. As the company is organically

equipped to distribute bulk class III and IIIA supplies only, the division transportation battalion must provide transportation for distribution and movement of class I, packaged class III, and quartermaster class II and IV supplies.

a. Organization. The quartermaster company is organized into the office of the division quartermaster, company headquarters, supply platoon, recovery and disposition platoon, and bath section (fig. 1).

b. Division Quartermaster Staff. The staff of the division quartermaster operates the office of the division quartermaster which is the nerve center of quartermaster operations in the division (fig. 2).

(1) *Division quartermaster.* The division quartermaster is charged with both staff and command responsibilities. He is a member of the special staff of the division commander. He commands all quartermaster elements in the division.

(a) *Staff responsibilities.* As a member of the division commander's special staff, the division quartermaster—

1. Provides technical advice and information for command policies and decisions affecting quartermaster operations.
2. Advises the division commander on quartermaster capabilities.
3. Advises the division commander on quartermaster supply and service

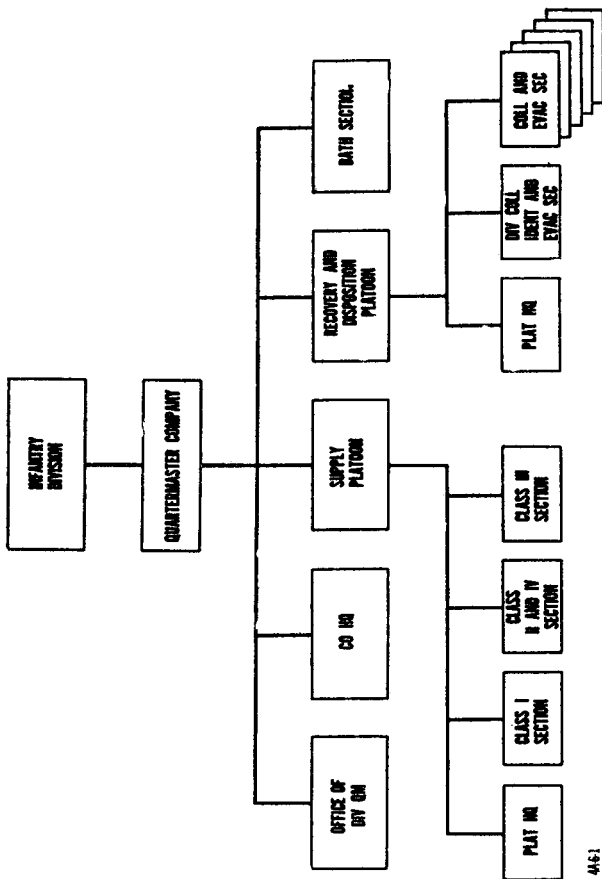

4431

Figure 1. Infantry division quartermaster company.

procedures, policies, schedules for supply, determination of requirements, and other quartermaster matters.

4. Brings to the attention of the division commander and general staff matters of quartermaster supply or service that require a command decision and, from continuous study of the situation, proposes emergency plans for the consideration of the commander.
 5. Formulates administrative instructions for dissemination through division administrative orders.
 6. Provides staff supervision of troop use of quartermaster supply and service by division units.
 7. Establishes, and supervises unit adherence to, schedules and procedures for quartermaster supply and service support.
 8. Coordinates division requirements with army quartermaster.
 9. Prepares the quartermaster section of division plans.
 10. Supervises food service activities in the division. See paragraph 92.
 11. Plans and coordinates aerial delivery operations.
- (b) *Quartermaster functions.* As commander of quartermaster activities in

the division, the division quartermaster—

1. Supervises training for all quartermaster troops in the division.
2. Directs quartermaster operations including supply, salvage collection, maintenance of quartermaster

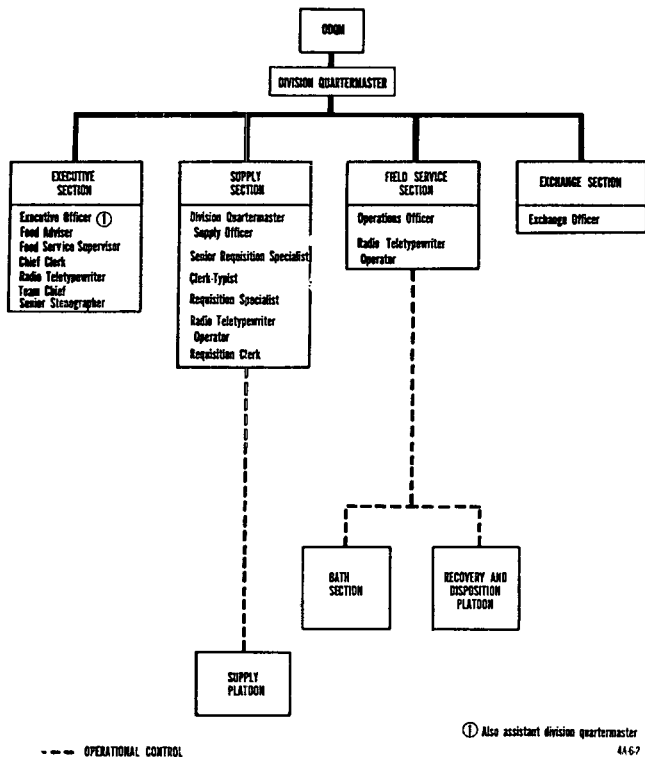

Figure 2. Organization of the office of the division quartermaster in an infantry division (suggested).

equipment, bath service, food service, initial identification and evacuation of deceased personnel, aerial delivery, and supervision of post exchange activities.

- (2) *Executive officer.* The executive officer supervises the executive section which is the administrative element of the office of the division quartermaster. The executive section—
 - (a) Prepares plans and establishes procedures for the technical operations of quartermaster installations of the division.
 - (b) Coordinates and supervises the activities of the office of the division quartermaster.
 - (c) Maintains the central files, including correspondence, regulations, circulars, bulletins, orders, and other papers.
 - (d) Maintains a situation map showing the location of quartermaster installations, supported and supporting units.
 - (e) Selects specific sites for division quartermaster installations within the general operating areas designated by the division trains commander.
- (3) *Division quartermaster supply officer.* The division quartermaster supply officer supervises the supply section of the office of the division quartermaster. This section—

- (a) Directs the activities of the supply platoon.
- (b) Determines division requirements for all classes of quartermaster supply.
- (c) Prepares schedules for the submission of unit requests and for the distribution of supplies to supported units.
- (d) Edits unit requests for supplies in accordance with requirements, authorization media, or availability; and consolidates or assembles division requisitions for transmittal to prescribed supplying agencies.
- (e) Recommends levels of reserve to be maintained.
- (f) Recommends priorities for the issue of regulated quartermaster items and other quartermaster items in short supply.
- (g) Supervises the operation of organic and attached supply elements of the division quartermaster organization.
- (h) Recommends general locations for distributing points.
- (i) Coordinates the division salvage program with G4 and with other technical services. Supervises collection and disposition of salvage at division salvage collecting points.
- (j) Coordinates the disposal of captured quartermaster-type materiel.

- (k) Supervises matters concerned with the maintenance and repair of items of quartermaster issue and the evacuation of items requiring higher echelon repair.
- (4) *Operations officer.* The operations officer supervises the field service section of the office of the division quartermaster. He also serves as purchasing and contracting officer and graves registration supervisor. The operations officer—
- (a) Plans efficient use of bath facilities and recommends troop bath schedules.
 - (b) Recommends standing operating procedures and plans for the guidance of personnel of the recovery and disposition platoon in coordination with attached or supporting elements.
 - (c) Maintains summaries and statistics on bath and graves registration operations.
 - (d) Handles division quartermaster purchasing and contracting requirements; acts upon requests for supplies, prepares contracts, and makes purchases.
 - (e) Coordinates supporting quartermaster laundry service.
- (5) *Exchange officer.* The exchange officer exercises staff supervision over the establishment and operation of unit exchanges as authorized by the division commander when such facilities are not

provided by the Army and Air Force Exchange Service.

(6) *Food adviser.* See paragraph 92.

c. Company Headquarters. Company headquarters is the command agency of the infantry division quartermaster company. It controls the administration, supply, mess, training, discipline, and security of quartermaster personnel assigned to the company. The activities of the company headquarters are the responsibility of the company commander.

d. Supply Platoon.

(1) *Platoon headquarters.* Platoon headquarters—

(a) Recommends locations for distributing points.

(b) Supervises operations of the platoon.

(c) Maintains supply records and prepares forms required for breakdown and delivery of quartermaster supplies to the division.

(2) *Class I section.* The class I section operates the class I distributing point, and maintains class I reserves.

(3) *Class II and IV section.* The class II and IV section provides for the supply of quartermaster class II and IV supplies, operates the class II and IV distributing point, if established, and maintains prescribed reserves. This section also operates the division salvage collecting point, furnishes limited (third-echelon) field

maintenance of quartermaster equipment; and provides limited packing and rigging of supplies and equipment for aerial delivery by army aircraft organic to the division.

- (4) *Class III section.* The class III section operates the division class III distributing point, mobile filling stations, and convoy refueling points, performs bulk reduction, and maintains the division reserve of class III and IIIA supplies.

e. Recovery and Disposition Platoon. The recovery and disposition platoon receives, makes initial identification, and prepares division dead for evacuation by army transportation.

f. Bath Section. The bath section operates shower points for division troops.

7. Other Quartermaster Units

a. Attachments. The division quartermaster commands and controls the activities of all quartermaster units attached to the division. The administration and operation of an attached unit are directed by the unit commander.

b. Nondivisional Quartermaster Units. Non-divisional quartermaster units supporting, but not attached to, the division include those within the chain of supply and service provided by higher echelons. These units establish and maintain liaison with the office of the division quartermaster.

Section II. THE ARMORED DIVISION

8. General

The armored division is a highly mobile force of great striking power. The armored characteristic of shock action which results from mobility, maneuverability, and concentrated armor-protected firepower, is brought to its maximum effectiveness by grouping in a combat command, combined arms units of tanks, armored infantry, armored artillery, and armored engineers, each contributing a specific type of action to the operation of the command. Supporting the combat commands are the service elements of the division, including the armored division quartermaster battalion.

9. Organization for Combat

a. The combat command headquarters is a tactical headquarters to which combat elements, including tank and armored rifle units, are attached. Attached combat units are organized as task forces tailored to fit each specific type mission. Combat support units (including armored artillery and armored engineer) and service support units (including ordnance and medical) are placed in direct support of or attached to the combat command as necessary.

b. For combat, the armored division commander normally establishes two echelons of division headquarters—the division main command post and the division headquarters rear echelon. The main command post consists of those staff agen-

cies immediately required to assist the commander in operations. The headquarters rear echelon is normally composed of the administrative services company, including its assigned special staff sections.

10. Organization for Logistics

a. *Division Trains.*

- (1) *Composition.* The division trains contain the necessary administrative and service support units, except signal and engineer, to provide logistical support and administration for the division as a whole. They may contain such additional attachments as the division commander directs. The division trains commander is a tactical commander directly responsible to the division commander.
- (2) *Organization for combat.* The combat organization of the division trains varies depending upon the type operation and the service support required forward with the combat commands. The armored division quartermaster battalion will normally conduct operations from the division trains area, locating quartermaster elements forward of the trains area as required by the tactical and logistical situation.

b. *Coordinating Agency.*

- (1) The division logistics control center (DLCC) is a control activity that operates under the supervision of the divi-

sion G4. Being a part of the division trains, the DLCC is tactically controlled by the division trains commander, who also provides for its administrative needs. The mission of the DLCC is to regulate, coordinate, and expedite logistical and personnel administrative support to the division combat elements. This mission is accomplished by locating control facilities at the DLCC for resupply, medical evacuation, maintenance, salvage collection, recovery and disposition of the dead, and certain other personnel administrative service functions of the division.

- (2) The DLCC is staffed by representatives from the division technical and administrative services. Division quartermaster representatives may include the division quartermaster supply officer and members of the supply and field service companies.

11. Armored Division Quartermaster Battalion

The Armored Division Quartermaster Battalion (TOE 10-45) (fig. 3) provides quartermaster supply and service in the armored division. It is composed of the Headquarters and Headquarters Detachment, Armored Division Quartermaster Battalion (TOE 10-46); Quartermaster Supply Company (TOE 10-47); and Quartermaster Field Service Company (TOE 10-48).

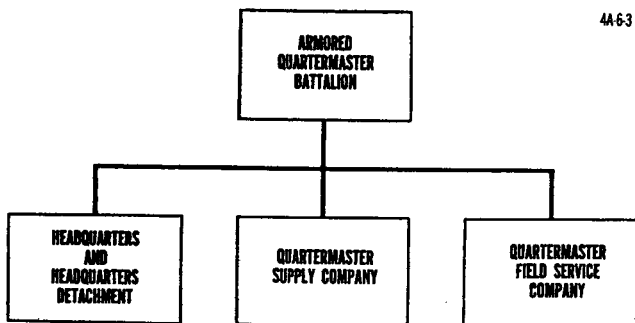

Figure 3. Armored division quartermaster battalion.

a. Headquarters and Headquarters Detachment. Headquarters and headquarters detachment (fig. 4) provides personnel for the office of the division quartermaster and for command and administration, and technical supervision of the armored quartermaster battalion. Although it is operationally self-sufficient, it is dependent upon the organic quartermaster supply company for messing and organizational maintenance of vehicles. Personnel services are provided by the Administrative Services Company, Armored Division (TOE 12-27).

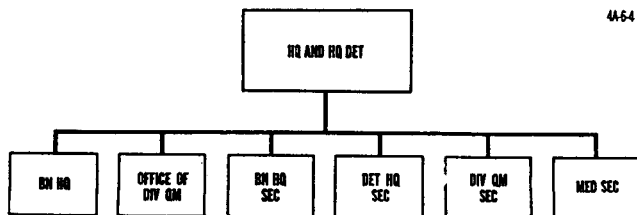

Figure 4. Headquarters and headquarters detachment, armored division quartermaster battalion.

- (1) *Division quartermaster staff.* The staff of the division quartermaster operates the office of the division quartermaster (fig. 5) which is the center of quartermaster activities in the division.
 - (a) *Division quartermaster.* The division quartermaster commands the armored division quartermaster battalion and is a member of the special staff of the division commander. As a special staff officer, he has functions and responsibilities similar to those of the infantry division quartermaster (par. 6b). As the battalion commander, he commands and is responsible for all activities of the armored quartermaster battalion.
 - (b) *Division quartermaster supply officer.* The division quartermaster supply officer is also the assistant division quartermaster. He supervises the office of the division quartermaster.
 - (c) *Supply officer.* The supply officer supervises the supply section which directs the activities of the quartermaster supply company. The duties of the section parallel those set forth in paragraph 6b(3).
 - (d) *Purchasing and contracting officer.* The purchasing and contracting officer supervises the field service section which directs the activities of the quartermaster field service company.

- ① Also assistant division quartermaster
- ② Also division recovery and disposition supervisor

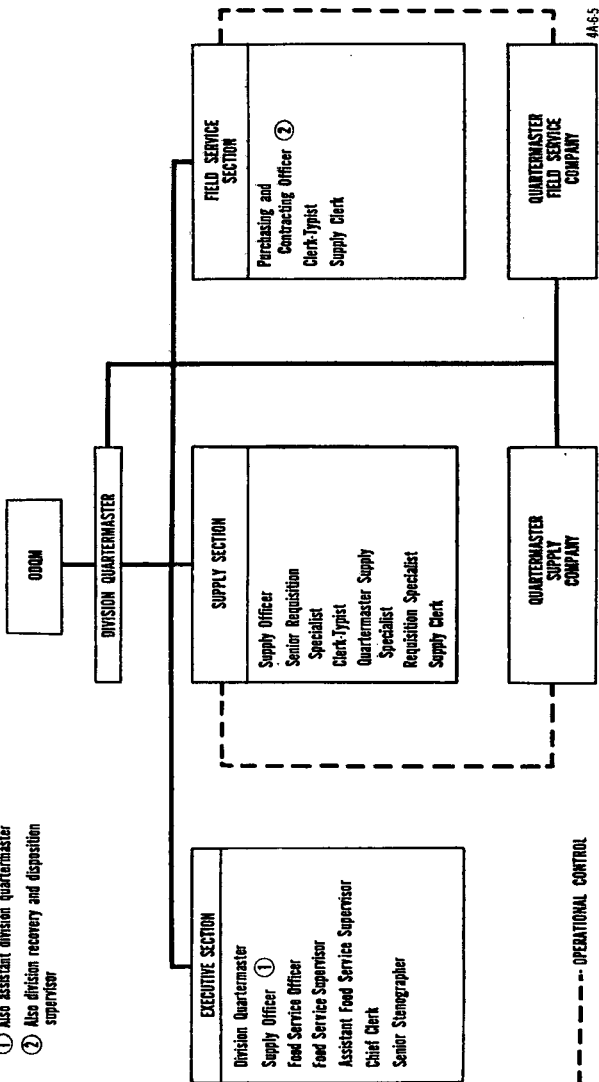

Figure 5. Functional chart, division quartermaster organization, armored division.

The duties of this section parallel those set forth in paragraph 6b(4). The purchasing and contracting officer is also the division recovery and disposition supervisor.

- (e) *Food adviser.* See paragraph 92.
- (2) *Battalion headquarters.* Battalion headquarters is the command element of the battalion and is responsible for directing and supervising the administration, discipline, supply, technical training, and security of the quartermaster troops in the division. The executive officer directs the activities of battalion headquarters for the battalion commander.
- (3) *Battalion headquarters section.* The battalion headquarters section provides the necessary enlisted personnel for the operation of battalion headquarters.
- (4) *Division quartermaster section.* The division quartermaster section provides the necessary enlisted personnel for the operation of the office of the division quartermaster.
- (5) *Detachment headquarters section.* The detachment headquarters section provides enlisted assistants for the detachment commander. The detachment commander also serves as battalion maintenance officer.
- (6) *Medical section.* The medical section provides emergency medical treatment, op-

erates the battalion aid station, evacuates casualties, and supervises sanitation for the battalion; headquarters and headquarters company, division trains; and band.

b. Quartermaster Supply Company. The basic function of the quartermaster supply company (fig. 6) is to provide class I and quartermaster class II, III, and IV supplies for the division. It also provides motor vehicle maintenance and messing facilities for the battalion headquarters and headquarters detachment. A member of the company will normally serve as the quartermaster representative at the DLCC (par. 10*b*).

- (1) *Company headquarters.* Company headquarters operates the company mess, provides second-echelon maintenance of organic equipment, and performs company supply and administrative functions.
- (2) *Supply platoon.* The supply platoon consists of a platoon headquarters, class I section, class II and IV section, and class III section. The division distributing points are operated by these sections. In addition to satisfying demands for quartermaster supplies in the division, each section will maintain the division reserve of its respective class of supply.
- (3) *Truck platoons.* The truck platoons transport supplies, personnel, and equipment as directed by the division quarter-

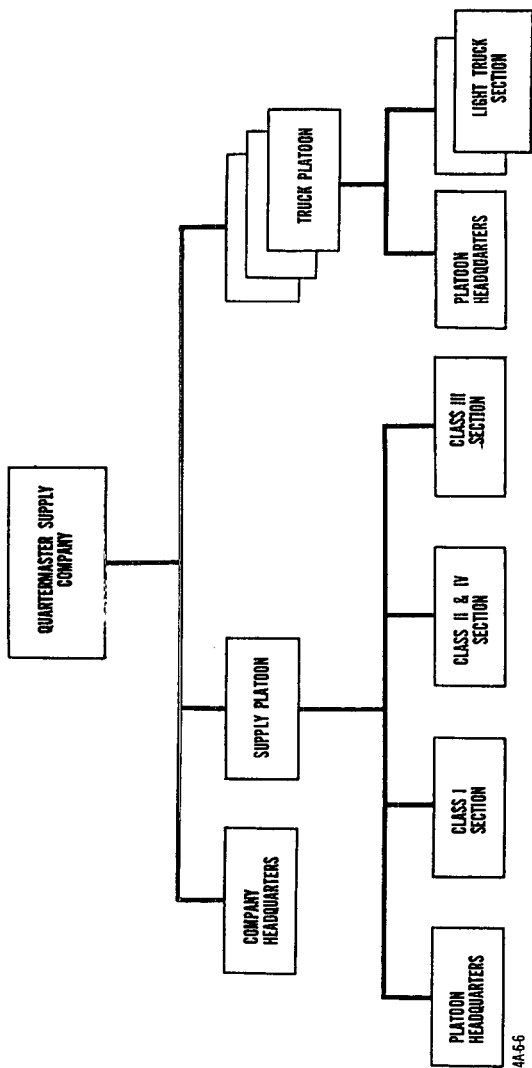

Figure 6. Organization of quartermaster supply company, armored division quartermaster battalion.

4A-5-6

master in accordance with requirements established by the division G4.

c. Quartermaster Field Service Company. The quartermaster field service company (fig. 7) provides bath and graves registration services for the division. It also provides motor vehicles to supplement the transport capabilities of the quartermaster supply company and other combat and service units of the division. A member of platoon headquarters may operate at the DLCC to coordinate graves registration activities for combat elements (par. 10b(3)).

- (1) *Company headquarters.* Company headquarters operates the company mess, provides second-echelon maintenance of organic equipment, and performs company supply and administrative functions.
- (2) *Bath section.* The bath section operates mobile shower units to provide baths for division troops. Normally one unit operates with each of the three combat commands and one with division trains.
- (3) *Recovery and disposition platoon.* The recovery and disposition platoon provides graves registration service for the division. When heavy casualties occur, the platoon will require support from nondivisional recovery and disposition units.
- (4) *Truck platoons.* Truck platoons transport supplies, personnel, and equipment

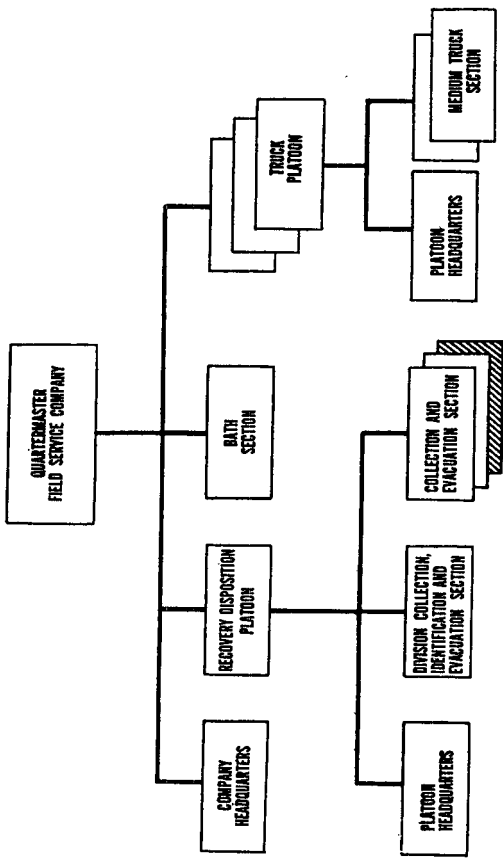

 NOT INCLUDED IN REDUCED STRENGTH COMPANY

44-67

Figure 7. Organization of quartermaster field service company, armored division quartermaster battalion.

as directed by the division quartermaster in accordance with requirements established by the division G4. They are used primarily to distribute quartermaster supplies beyond the capacity of the quartermaster supply company. In addition, the company will furnish, when necessary, the cargo transportation required to operate a division mobile class V supply point.

Section III. THE AIRBORNE DIVISION

12. General

The airborne division is a self-contained unit of combined arms and services designed primarily to conduct airborne operations independently or as part of a larger force. It can move by air to neutralize, seize, defend, or destroy objectives in enemy territory. It can be effectively employed without major resupply or reinforcement for 72 hours, but must be augmented for sustained operations over longer periods of time. All combat elements of the division are air-transportable by either air-landing or parachuting into the objective area.

13. Organization for Combat

Like the infantry and armored divisions, the airborne division allows for flexible combat groupings of elements to meet the division commander's plan for a specific mission. The airborne battle group is the basic tactical unit of the airborne

division. To this are added combat and support elements as determined by the division commander.

14. Organization for Logistics

a. Plans and Policies. Formulation of division logistical policies, development of division logistical plans, and general staff supervision of division logistical operations are responsibilities of the division G4.

b. Logistical Operations. Control, direction, and supervision of division logistical operations are responsibilities of the airborne support group. As a major subordinate commander of the division, the support group commander commands units organic to the airborne support group. As a member of the division commander's special staff, he supervises and directs the service and supply units engaged in logistical support of the division.

c. Airborne Support Group. The airborne support group consists of a group headquarters and headquarters detachment; airborne maintenance battalion; airborne quartermaster parachute supply company; airborne supply and transportation company; and airborne division medical company. The functional staff of the support group commander consists of the division maintenance officer, division supply officer, division surgeon, and division parachute supply officer.

d. Coordinating Agency. The division logistics control center (DLCC) is an agency established for the coordination and supervision of logistical operations other than those handled on a pre-

planned or supporting-agency-direct-to-user basis. The DLCC is normally established in the objective area and staffed with the minimum number of representatives of the functional staff required to support the operation. The DLCC will normally be located at the support group command post and will be under the direction of either the deputy commander or executive officer of the support group.

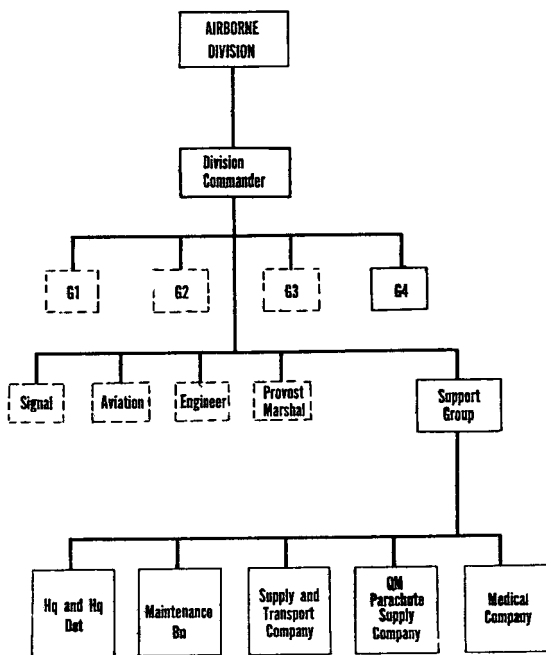

4A68

Figure 8. Organization for logistics in the airborne division.

15. The Airborne Division Supply and Transportation Company

The Airborne Division Supply and Transportation Company (TOE 29-57) is organic to the airborne support group. It provides all classes of supply, except repair parts, aircraft parts and supplies, medical supplies, maps, water, and quartermaster air-type equipment. It provides and operates transportation, except aircraft, to distribute supplies to division units and to supplement transport available to other elements of the division. The company is dependent upon the headquarters and headquarters detachment airborne support group for administration and upon the headquarters and rear support company, airborne maintenance battalion for motor maintenance.

a. Organization. The supply and transportation company is organized into company headquarters, supply platoon, and transportation platoon (fig. 9).

b. Office of the Division Supply Officer. The personnel comprising the office of the division supply officer are contained in company headquarters.

- (1) *Division supply officer.* The division supply officer serves as adviser on the functional logistical staff of the airborne support group commander. During the planning phase of an operation, the division supply officer must also be available to the division staff on a direct contact basis. The division supply officer supervises—

- (a) Requisitioning and distribution of class I, class II and IV, class III, class IIIA, and class V supplies.
 - (b) Transportation of personnel, supplies, and equipment.
 - (c) Operation of division distributing points for class I, class II and IV, class III and IIIA, and class V supplies, when established.
 - (d) Explosive disposal service.
- (2) *Assistant division supply officer.* The assistant division supply officer assists the division supply officer in coordinating operations of the airborne supply and transportation company.
- (3) *Division food adviser.* See paragraph 92.

c. Company Headquarters. The company headquarters provides the necessary command and supervision for the unit to include planning and coordinating operations of the company, administration, mess, communication, security, and training activities. The company commander is responsible for the establishment of the company command post and routine administrative activities of the unit.

d. Supply Platoon.

- (1) *Class I section.* The class I section determines class I requirements, prepares the division daily ration request, maintains and transports division reserves as required and operates the class I distributing point, when established.

- (2) *Class II and IV section.* The class II and IV section assemblies or consolidates division class II and IV requirements, submits requisitions to the appropriate supply agencies, maintains and transports division reserves as required and operates the class II and IV distributing point, when established.
- (3) *Class III section.* The class III section determines division class III and IIIA requirements, prepares and submits the daily status report on class III and IIIA supplies, maintains and transports division reserves as required and operates the class III distributing point, when established.
- (4) *Class V section.* The class V section submits reports covering required supply rates, maintains records and data on available supply rates, authenticates ammunition requests (transportation orders), provides explosives disposal service, and operates the class V distributing point, when established.

e. Transportation Platoon. The transportation platoon consists of a platoon headquarters and two identical truck sections. The platoon is capable of moving, in one lift, 160 short tons of general supplies, 800 combat-equipped personnel, or a combination of the two.

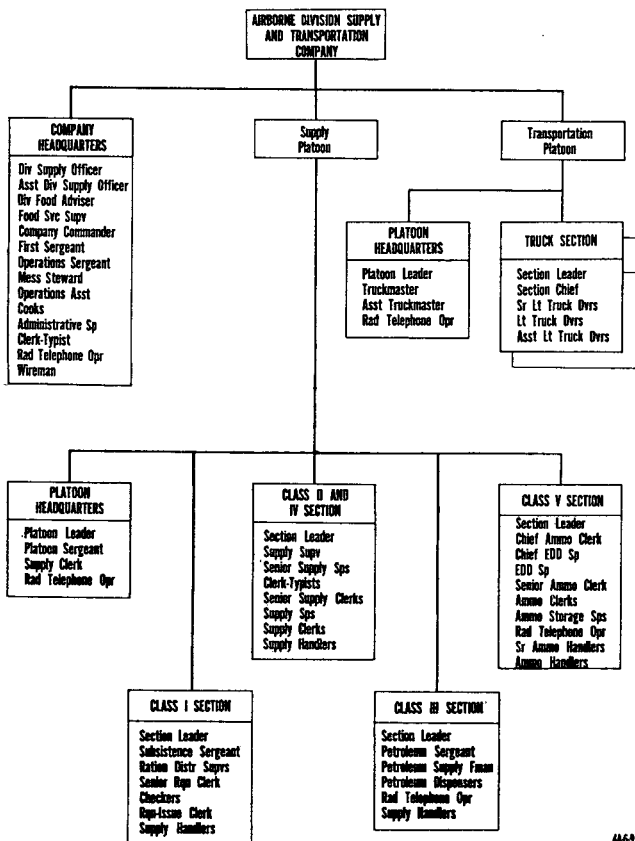

446A

Figure 9. Airborne division supply and transportation company.

16. The Airborne Division Quartermaster Supply Company

a. Mission. The Airborne Division Quartermaster Parachute Supply Company (TOE 10-337) supports the airborne division by providing facilities to—

- (1) Requisition, inspect, pack, store, maintain, and issue quartermaster air-type equipment for aerial delivery of personnel, supplies, and equipment.
- (2) Inspect and furnish technical assistance in packing, rigging, and loading supplies and equipment for aerial delivery.

b. Capabilities. The airborne division quartermaster parachute supply company is capable of receiving and storing the equipment required to pack, rig, and load supplies for all division elements prior to an airborne operation to include the first three days accompanying supplies. After the division is committed, the continuing daily supply requirements must be provided by non-divisional support units.

c. Organization. The company (fig. 10) is organized into—

- (1) *Company headquarters.* Company headquarters provides the command and supervision of administration, mess, operations, communications, security, and training of the company.
 - (a) *Company commander.* The company commander is also the division parachute supply officer; and, in this

capacity, is a member of the support group commander's staff.

- (b) *Operations officer.* The operations officer assists the company commander in directing and supervising the operations of the company.
 - (c) *Parachute maintenance officer.* The parachute maintenance officer is responsible to the company commander for the maintenance and repair of parachutes and related quartermaster air-type items handled by the company.
- (2) *Supply platoon.* The supply platoon requisitions, stores, and issues quartermaster air-type equipment for the division; maintains supply records on these items; inspects and assembles aerial delivery kits; and provides personnel to supervise the shake-out and drying of parachutes.
 - (3) *Maintenance platoon.* The maintenance platoon is responsible for organizational maintenance on quartermaster air-type equipment in the division. Platoon personnel may also be required to assist in the operations of the packing platoon or aerial delivery platoon.
 - (4) *Packing platoon.* The packing platoon inspects and packs personnel and light cargo parachute assemblies and assists in fitting and adjusting parachutes to wearers. It also assists in the recovery

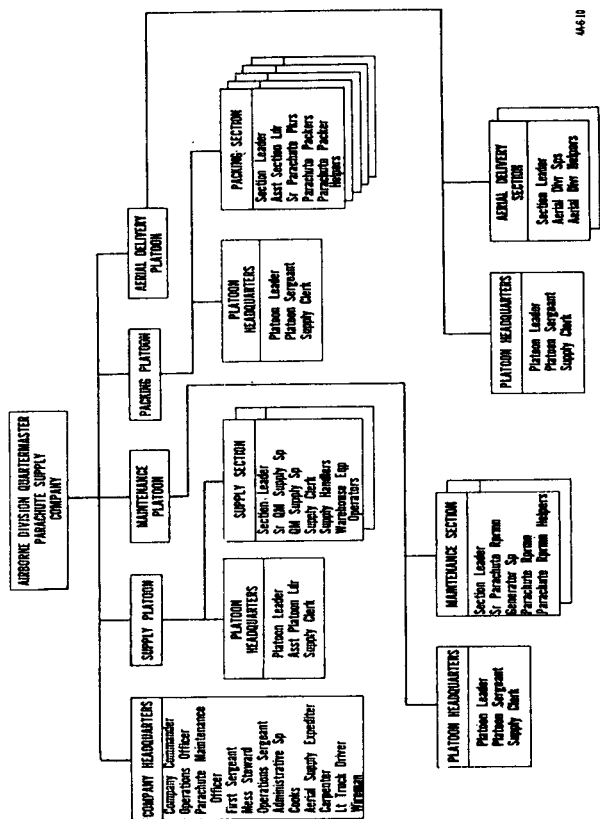

Figure 10. Airborne division quartermaster parachute supply company.

and evacuation of quartermaster air-type equipment.

- (5) *Aerial delivery platoon.* The aerial delivery platoon packs heavy cargo parachutes, rigs aerial delivery kits, prepares aerial delivery containers, and provides technical assistance to division units in preparation for airborne operations.

CHAPTER 3

LOGISTICS—SUPPLY

Section I. GENERAL

17. Principles

a. Tactics and supply are closely connected, therefore, tactical and supply plans must be prepared in close coordination. The tactical plan must be supportable by adequate supply. Supply plans and techniques must be tailored to provide maximum support of the specific military operation.

b. Supply plans must provide for simplicity and continuity. Continuity of supply requires constant anticipation of needs and timely delivery of supplies.

c. Supply plans must have the flexibility to adjust rapidly to fluctuating consumer demands.

d. Supply activities must emphasize—

- (1) Rapid delivery of supplies from rear to front by all available means.
- (2) Reduction of the physical burden of supply by the maintenance of an accurate pipeline of supplies, backed by a limited reserve.
- (3) Optimum dispersion of supply installations in direct support of major combat elements.

e. Supplies are moved forward from the rear to the consuming troops. Each element in the supply chain makes known its needs to its supporting echelon in sufficient time to permit normal delivery. The division quartermaster or airborne division supply officer will normally arrange for unit distribution of supplies to supported units. However, this specific method, must not be considered inflexible. The method and organization for supply must accomplish maximum support of tactically active units.

f. Adequate supplies are provided without burdensome excess. Combat separates units and individuals from their source of supply and they must frequently be self-sustaining. To meet this situation, supply needs are anticipated and reserves are carried for individuals and vehicles. As any increase in the amount of supplies carried decreases mobility, the solution that gives reasonable certainty of supply and yet retains tactical mobility will be adopted. Effective supply economy decreases the amount of supplies required during movements.

g. Reserve levels must be in consonance with effective supply support and maximum mobility.

h. Adequate plans must be prepared to re-establish supply channels when interrupted, or to quickly divert the logistical effort into alternate channels.

i. Contact with the logistical situation in all units of the division must be maintained by liaison and not by reports alone.

j. Current concepts of employment for the division emphasize the importance of air movement of personnel and supplies. Both organic and supporting aviation should be utilized to the maximum. Division G4 should plan simultaneous supply and evacuation by air for the economical accomplishment of air support missions. Use of air transport will be considered routine and not confined to emergencies.

18. Supply Responsibility

At division level, supply includes determination of requirements, procurement, storage (when necessary), and issue of supplies and equipment. Supply points of higher echelons normally deliver supplies in bulk to division distributing points for distribution to division units. Major organization commanders submit requirements to division supply elements and arrange their own internal distribution.

19. Supply Requirements

Supply requirements include all supplies needed for equipping, maintaining, and operating the division for a specific period of time or for a specific operation.

a. Basis. Normally, requests are based on authorized allowances, estimates of consumption of class I and III items, replenishment needs of II and IV items, and authorized reserves. Authorized allowances, prescribed in tables of organization and equipment (TOE), and equipment modification lists (EML), and special authoriza-

tions are used to compute initial equipment requirements. Modified by current strength and expenditure reports, they also provide the basis for computation of current needs and reserves.

b. TOE's. The division quartermaster or airborne division supply officer should maintain a current file of TOE's in order to edit unit requests for class II and IV items, as well as to obtain information on vehicular and fuel container allowances needed for logistical planning of class III operations. TOE's are not normally used in determining class I requirements as daily strength for rations reports are the immediate basis for requisitions and accurately reflect current unit strength.

20. Procurement of Supplies

a. Requisition. When supply requirements have been determined, each class of supplies is obtained by requests upon appropriate supply elements of higher headquarters. Requests from supported units are consolidated or assembled by the appropriate division quartermaster supply section and forwarded to the designated army depot or supply point. The supplies received at division as a result of these requests are broken down for delivery to the units.

b. Purchase. The division purchasing and contracting officer will normally be authorized to make limited purchases from local sources, subject to limitations imposed by the army commander. When authorized, purchases will include only those items not available through supply

channels and must be within the limitations of funds allotted.

(1) *Friendly countries.*

(a) *Indirect procurement.* Indirect procurement is the usual method of obtaining supplies and equipment by local purchase in friendly countries. A requisition is placed directly with local civil authorities, who as agent for their government, purchase the required supplies for the United States forces. Price and payment are arranged between the vendor and his own government. Indirect procurement is made possible by long-range financial agreements between the respective governments.

(b) *Direct procurement.* Desired items may be requested by the purchasing and contracting officer directly from the vendor when local civil authority is not organized to handle requisitions.

(c) *Direct purchase.* Direct cash purchase may be authorized by higher headquarters for small amounts of supplies.

(2) *Enemy countries.*

(a) *Confiscation.* Confiscation is the authorized seizure of property of the enemy state. Procedures will be in conformity with existing regulations, orders of higher authority, and the Law of Land Warfare. Unauthorized

seizure of property is punishable as looting.

- (b) *Requisition.* Requisitions may be placed on local civil authorities or directly upon vendors as in friendly countries. Prices are fixed by the purchaser and the owner has no option in the transaction. Payment to the individual or to the enemy state is deferred.
- (c) *Purchase.* In exceptional cases, limited amounts of supplies may be purchased.

Section II. DIVISION DISTRIBUTING POINT REQUIREMENTS

21. General

Distributing points are normally established for all classes of supply. These are points at which supplies are received and broken down or otherwise prepared for issue or delivery to subordinate units. For class I and class III supplies, these may be definite locations for the processing of requisitions and the distribution of subsistence and petroleum products. For classes II, IV, and V, distributing points are more likely to be vehicles or rendezvous points from which users obtain these classes of items on a preplanned schedule or on previously processed requisitions. Such points maintain no stocks. They exist only for the purpose of, and for the time required for, distribution of supplies on hand. Particular situations may require the establishment of multiple

distributing points for particular classes of supply or the issuance of fast-moving items of quartermaster class II and IV supplies, such as socks and underwear, through class I distributing points.

22. Site Selection

In any type action there are three factors governing the selection of the locations for division supply installations: ability to perform the mission, defensibility, and dispersion.

a. The considerations under *ability to perform the mission* are as follows:

- (1) Favors main attack.
- (2) Within reasonable trucking distances of troops supported.
- (3) Avoids back tracking of supplies and/or personnel.
- (4) Suitable roads forward, to the flanks, and to the rear.
- (5) Good interior road net, hard standing, and shelter for supplies and supply operations.
- (6) Operating troops located reasonably nearby.

b. The considerations under *defensibility* are as follows:

- (1) Suitable terrain for defense, particularly against ground attack.
- (2) Size which permits defense by installation troops.
- (3) Provides defilade, cover, and concealment.

- (4) Proximity to friendly troops.
- (5) Safety of location (to rear in defense, center of airhead, etc.).

c. The considerations under *dispersion* are as follows:

- (1) Adequate space within area to minimize losses of men, equipment, and supplies from enemy action.
- (2) Separated from other logistical installations and tactical or administrative units.

Section III. SECURITY

23. General

The division G3 is responsible for the division rear area defense plan. The G4 supervises the division area damage control plan. The division trains commander, so far as division trains elements are concerned; or airborne support group commander, when the support group is allotted a specific sector of the airhead, is responsible for the coordination and implementation of detailed plans and standing operating procedures for rear area defense and damage control.

24. Communications

A system must be provided to alert personnel within quartermaster installations. This may be done by wire, radio, messenger, or other means. The system should include alternate means of contact, particularly with outlying installations. Communications diagrams should be maintained.

25. Security Measures

Security measures should be adapted to the operation site or bivouac area and coordinated with those of adjacent units. Protective measures should not be so excessive as to destroy the mobility of the distributing points. Guards should be posted at entrances to bivouac and operation sites and aircraft spotters should be assigned.

26. Training

Security and destruction plans should include special training in individual weapons, tactics, practice alerts, signal communications, field exercises, defense against airborne and guerilla tactics, and procedures for the destruction of supplies and equipment.

27. CBR and Nuclear Defense

CBR and nuclear defense plans should be coordinated with the division chemical officer, G3, G4, and trains or support group commander. Special protection against CBR or nuclear attack may be required for particular installations. Foxholes for individuals, emplacements for weapons, and revetments or cuts for vehicles should be used. A study of the terrain may show caves, steep hills, cuts, mines, tunnels, or other underground features that may afford cover or concealment. Underground protection should provide more than one opening to permit air circulation, control moisture, minimize possible entrapment or entombment of personnel, and provide for simultaneous receipt and issue of supplies.

CHAPTER 4

CLASS I SUPPLY OPERATIONS

Section I. SUPPLY REQUIREMENTS

28. General Characteristics

a. Class I supplies are items consumed at an approximately uniform daily rate under all conditions.

b. Rations are the principal class I items. In the division they consist largely of field rations (type A); operational rations (type B); individual combat rations; and small detachment rations (5 persons). Individual assault food packets ration supplements, aid station packs, or substitute components are issued as required. As class I supplies represent a tonnage problem because of the great weight of the rations consumed daily, distribution procedures must be based on careful planning of transport, ration breakdown, and delivery.

29. Amounts Required for Current Consumption

Class I supply requirements depend upon daily ration requests submitted by units of the division and upon unit strength reports maintained at division headquarters. They are affected by requirements for the division class I reserve and other factors not reflected in unit requests and strength reports.

30. Ration Augmentation

a. Unit commanders may be authorized to augment the ration when troops are active in combat or to meet unusual dietary needs. Such authorization must be based upon recommendation of the division surgeon and division quartermaster or airborne division supply officer and have the approval of the division commander.

b. Troops may, upon recommendation of the division surgeon and quartermaster or airborne division supply officer and with the approval of the division commander, be authorized four meals per day. When large fluctuations in mess attendance warrant the issue of rations on a meal basis within certain units, requests for such type of issue may be forwarded through command channels for approval.

31. Authorized Reserves

a. Composition. The class I reserve for the division is authorized and its level limited by army headquarters. Within these limits, the actual reserve level for the division will be prescribed by the division commander on recommendations of the division quartermaster or airborne division supply officer. This level will be influenced by the type of probable combat, distance to army class I supply points, and amount and type of transportation available. In the infantry division, the class I reserve is carried on the trailers of the division transportation battalion. In the armored division, part of the reserve rations are carried by unit kitchens or in unit vehicles for the emer-

gency needs of individuals, and the balance is held by the quartermaster supply company. In the airborne division, rations for three days normally accompany the assault echelon and the prescribed division reserve is maintained and transported by the airborne supply and transportation company.

b. Acquisition. Initial reserve stocks and replenishments as needed are obtained as part of current requirements by additions to the daily ration request. The amounts required and the authority for them must be indicated on the request form.

c. Use. Reserve rations are authorized to cover emergency requirements. To insure adequacy when needed, they require periodic inspection and constant protection against theft, damage and deterioration. They should be used to absorb minor issue shortages and to help cover unforeseen variations in unit strength. A system of reserve stock turnover should be employed. This may be a regular issue of a fixed percentage of reserve stocks and simultaneous replenishment or periodic issue and replacement of the entire reserve.

32. Miscellaneous Supplies

a. Soap, toilet paper, insecticides, candles, socks, and similar fast-moving items may be issued through class I distributing points.

b. When recommended by the division surgeon, salt and malaria suppressive tablets may be issued with rations and made available to personnel at mess.

c. The sundries pack will be issued gratuitously through class I channels in the combat zone and when sales facilities are not available. The division quartermaster or airborne division supply officer will normally stock toilet articles, candy, and tobacco products at the class I distributing point for issue on a daily basis.

Section II. SUPPLY ADMINISTRATION

33. Responsibility

Administration of class I supply is a function of the supply section of the office of the division quartermaster or the supply platoon of the airborne supply and transportation company.

34. Computing Ration Breakdown

a. *Required Information.* To determine the quantity of each ration item to be issued, unit ration requests must show—

- (1) Designation of the unit.
- (2) Consumption date for requested rations.
- (3) Type of rations and quantity of each type required.

b. *Computing Procedure.* For types A and B rations, the unit allowance of each component per 100 men is shown in the published daily menu. Allowances are computed to the nearest whole unit of issue. Unit strength is multiplied by the 100 man allowance and this product is divided by 100. In combat-type rations components are fixed and this procedure is not necessary.

c. *Forms.* Breakdown and issue forms are used to tabulate unit allotments, check unit and item-

ized totals against division bulk total, assist class I personnel in distribution, and record completed transactions.

- (1) *Master ration breakdown sheet.* The master ration breakdown sheet (fig. 11) lists and tabulates unit allotments for items authorized in the daily menu and should include a breakdown of combat-type rations in the current issue.
- (2) *Unit ration breakdown sheet.*
 - (a) When the master ration breakdown sheet is completed, a separate breakdown sheet (fig. 12) is prepared from it for each supported unit. Items and quantities are listed.
 - (b) The unit ration breakdown sheet should be prepared in duplicate; one copy to be used by the class I section in issuing; the other for information of the supported unit.
- (3) *Ration breakdown worksheet.* A ration breakdown worksheet (fig. 13) may be used in conjunction with the item pile method of breakdown (par. 49b). It shows identity of the drawing unit and quantity of item issue as obtained from the master ration breakdown sheet. Each worksheet should be totalled separately and checked against unit and division allowances to provide added safeguard against error. It does not replace, nor will it be used instead of, the

MASTER RATION BREAKDOWN SHEET		Disintegrating Point 20										Date of Issue 10 JUN		Date of Consumption 11 JUN			
INGREDIENTS	WEIGHT PER 100	ORGANIZATION										20th INF Bn	1st TANK Bn	20th INF Bn	20th INF Bn		
		1/11 INF	2/10 INF	3/10 INF	4/10 INF	5/10 INF	6/10 INF	7/10 INF	8/10 INF	9/10 INF	10/10 INF					11/10 INF	12/10 INF
RAVON BARRON																	
NUMBER OF BILLS ISSUED																	
BEANS, SWAP, GREEN	4	25	25	24	56	60	86	20	28	12	21	13	315				
BEER, CONDENSED	4	25	—	25	21	56	60	86	80	28	21	13	315				
BREAD, WHITE	10	43	—	63	72	140	150	45	50	70	30	52	31	785			
COFFEE, REG	10	63	—	63	72	140	150	45	50	70	30	52	31	786			
Eggs, whole, fresh	8.3	15	—	15	17	32	35	15	12	16	7	12	7	183			
Flour, wheat, hard	10	63	—	63	72	140	150	45	50	70	30	52	31	785			
JAM	1	7	—	7	7	14	15	7	5	7	3	6	3	81			
JUICE, PLUMS, COND	12	75	—	76	87	168	180	78	60	84	36	63	36	943			
LUNCHEON MEAT, COND	4	25	—	25	29	56	60	46	20	28	12	21	13	315			
MILK, WHOLE, DEV	5	32	—	32	36	70	75	33	25	35	15	26	16	395			
MILK, EVAPORATED	15	94	—	95	108	180	225	98	75	105	45	78	47	1150			
DA FORM 2071-4 1-28-55																	

Figure 11. Master Ration Breakdown Sheet (DA Form 2057-R).

UNIT RATION BREAKDOWN SHEET		Date 10 JUNE			
Supply Point	Organization	STRENGTH			
		A or B Ration	630		
20 th Inf Div	3 d BG, 63 rd Div	Other (Specify)	5-14-1		
		Other (Specify)	770		
		Other (Specify)			
		Other (Specify)			
ITEM	UNIT	ALM PER 100	PACK	QUANTITY ISSUED	
				Total Units	Broken Packages
Cheese, snap, green	7/8 can	4	4/case	25	4 cases 1 can
Beef corned, canned	6 1/2 lb can	4	20 marbled	26	---
Bread, white	20 egg	10	50 4oz/box	63	1 box 13 packages
Coffee, R46	lb.	10	20 lb can	63	3 cans 3 lbs
Eggs, whole, dried	7/8 can	2.3	6/case	15	2 cases 3 cans
Flour, wheat, hard	lb.	10	50 lb. bag	63	1 bag 15 lbs
Jam	7/8 can	1	4/case	7	1 case 1 can
Juice, pineapple, canned	3/4 gal	12	24/case	76	3 cases 4 cys
Lunch meat, canned	6 lb can	4	6/case	25	4 cans 1 can
Milk, whole, dry	lb.	5	5 lb can	32	6 cans 2 lbs
Milk, evaporated	14oz can	15	48/case	95	2 cases ---
Ration, S-1	ration	100	5/case	770	154 cases ---
Name and Grade		John Jones, Capt, PMC		Signature John Jones	

DA Form 2059-R
1 Jan 58

4437

Figure 12. Unit Ration Breakdown Sheet (DA Form 2059-R).

RATION BREAKDOWN WORKSHEET		
Item No. <i>1</i>	Issue Date <i>10 June</i>	
Item <i>Beans, snap, green</i>	Unit <i>#10 can</i>	
Units in Case <i>6</i>	Cases Required	
Total Units From Stock <i>315</i>	<i>53</i>	
ORGANIZATION	ALLOWANCE	ISSUE
<i>1/61 Inf</i>	<i>25</i>	<i>25</i>
<i>4/64 Inf</i>	<i>29</i>	<i>29</i>
<i>3/63 Inf</i>	<i>25</i>	<i>25</i>
<i>5/65 Inf</i>	<i>56</i>	<i>56</i>
<i>Div Arty</i>	<i>60</i>	<i>60</i>
<i>1st Recon Sq</i>	<i>26</i>	<i>26</i>
<i>20th Sig Bn</i>	<i>20</i>	<i>20</i>
<i>20th Engr C Bn</i>	<i>28</i>	<i>28</i>
<i>20th Med Bn</i>	<i>12</i>	<i>12</i>
<i>1st Jk Bn</i>	<i>21</i>	<i>21</i>
<i>20th Rad Bn</i>	<i>13</i>	<i>13</i>
TOTAL	<i>315</i>	<i>315</i>
Balance On Hand <i>3 cans</i>		
Issued By <i>Jack Smith, Cpl, RA. 16 333 353</i>		

DA Form R-5676
1 Sep '55

4A-13

Figure 13. Ration Breakdown Worksheet
(DA Form R-5676).

unit breakdown sheet for issue to individual units.

- (a) Only one worksheet is required for each issue.
- (b) The worksheet may be retained at the distributing point as a record of overissues and underissues.

35. Adjusting Breakdown Allotments

a. Substitutions. Type, quantity, and condition of class I supplies are checked at the army supply point. Substitutions are noted on the ration breakdown sheet prepared at the supply point. A copy is furnished the division class I distributing point for check.

b. Forms. The necessary forms for division breakdown are prepared before the arrival of rations from the army supply point. These forms will normally include master ration breakdown sheet, and unit ration breakdown sheet.

c. Corrections. Published menus and allowances are subject to change and substitution. The supplies listed on the ration breakdown sheet when issued by the army supply point are the only accurate basis for determination of issue. When these are delivered to the division class I distributing point, it may be necessary to change unit ration breakdown sheets and to notify units of changes in the published menu.

36. Schedules of Breakdown and Delivery

a. Time Factor. For planning purposes, average time factors are detailed in FM 101-10, but the

actual schedule for breakdown and delivery will depend upon—

- (1) Time of arrival and rations at distributing point.
- (2) Time required to unload and to correct breakdown and issue forms.
- (3) Time required for breakdown.
- (4) Time required for delivery.
- (5) Waiting time, if delivery must be at night.

b. Ration Cycle. A ration cycle is the 24-hour period in which a ration is consumed. It is normally the day after issue, but is established by division order. The meal which opens the cycle will depend on—

- (1) Army schedule for delivery of bulk supplies.
- (2) Length of haul from distributing point to consuming units.
- (3) Availability of transportation.
- (4) Time available at the distributing point for breakdown and delivery.
- (5) Type of rations.

c. Delivery Schedule. A delivery schedule approved by the division G4 will be published in administrative orders or by message. Units will be advised of changes. The schedule will be based on the ration cycle and will be modified to provide priority to the following:

- (1) Units in contact with the enemy.
- (2) Units farthest from the distributing point.

- (3) Groups and other large units which must make a further breakdown and delivery to consuming unit kitchens.

Section III. REQUISITIONING

37. Daily Ration Request

Class I supplies are normally requisitioned by means of the daily ration request (fig. 14). Under certain circumstances however, rations may be supplied based on strength figures received through G-1 channels. When such system is employed, ration requests are submitted only in such cases wherein the estimated strength for ration figures vary substantially from morning report strength, a specific type ration is desired, or if reserve rations require replacement.

38. Ration Interval

The ration interval is the elapsed time between the forwarding of the unit daily ration request and the date of consumption.

39. Required Data

Estimated strength and morning report strength are the most important information on the daily ration request.

a. Estimated Strength. The estimated strength shows the number of troops for which rations will be required on the consumption date. It is based on current experience data covering meal attendance and on probable casualties and replacements during the ration interval.

RATION REQUEST FOR THEATERS OF OPERATION

Headquarters <i>20th Inf Div</i>		Location <i>P 864 973</i>		Date <i>8 June</i>	
To <i>Army Class I SP 571</i>		Ration Request For			
Issue Date <i>JUN 10</i>		Consumption Date <i>JUN 11</i>			
Troop Strength					
Organic Units	Unit Destination	Morning Report Strength	Average Estimated Strength		
	<i>20th Inf Div</i>	<i>12,400</i>	<i>11,928</i>		
Attached Units and Casuals					
Total Troop Strength			<i>11,928</i>		
Special Group Strength					
Civilians					
Prisoners of War					
Others (Specify)					
Animal Strength					
Horses and Mules					
Dogs					
Rations Desired					
Type	Number	Type	Number		
<i>B</i>	<i>7,827</i>				
<i>5 in 1</i>	<i>2,421</i>				
<i>Infantry Combat</i>	<i>1,680</i>				
Remarks					
Hour and Date Sent <i>1000 8 June</i>			Method of Transmittal <i>Officer Courier</i>		
Name and Grade <i>Capt. G.M.C. John Jones</i>			Signature <i>John Jones</i>		

DA Form 2058-R
1 Jan 58

4A-6-14

Figure 14. Daily Ration Request for Theater of Operations (DA Form 2058-R).

b. Morning Report Strength. Morning report strength affords a means for comparing actual strength with previous estimates. Substantial differences in the two, not accounted for by meal attendance variations, should be investigated.

40. Requisitioning Procedure

a. Division Units. Groups and separate battalions are the first consolidating headquarters. Subordinate units submit estimated strength for rations for the consumption date to group or battalion supply officers. These unit requests are consolidated and forwarded to the division quartermaster or airborne division supply officer. The type of rations requested will be prescribed by the group or battalion commander, based on the tactical situation. Separate company supply officers submit their daily company ration requests directly to the division quartermaster or airborne division supply officer.

- (1) When several types of rations are requested or when the total number requested exceeds the average estimated strength, an explanation should be made in the remarks section of the request.
- (2) When subordinate units report an excess of ration items on hand, an adjustment of these should be reflected in the division request. Normally, items not required or required in reduced amounts should be indicated in the remarks section or on the back of the request form.

b. Divisions. The division quartermaster or airborne division supply officer is responsible for the consolidation of daily ration requests of all subordinate units into a division daily ration request (fig. 15). The consolidated request is forwarded to the appropriate class I supply point. Coordination with division G1 will insure that a reasonable balance is maintained between actual needs and amounts requested.

- (1) Consolidated division requests should include authorized additional requirements to maintain reserves or to meet emergencies.
- (2) The division request should also include estimates to cover units and casualties for which separate requests were not submitted but for which, as division attachments, it is expected that rations will be required on the consumption date.

c. Emergency Needs. When emergency demands arise during the ration interval, the division quartermaster or airborne division supply officer—

- (1) May issue rations from division reserves.
- (2) May submit supplemental requests to supply points if the reserves will not meet the needs.

Section IV. DISTRIBUTION

41. General

Class I supplies are normally forwarded from the class I distributing point. Under exceptional

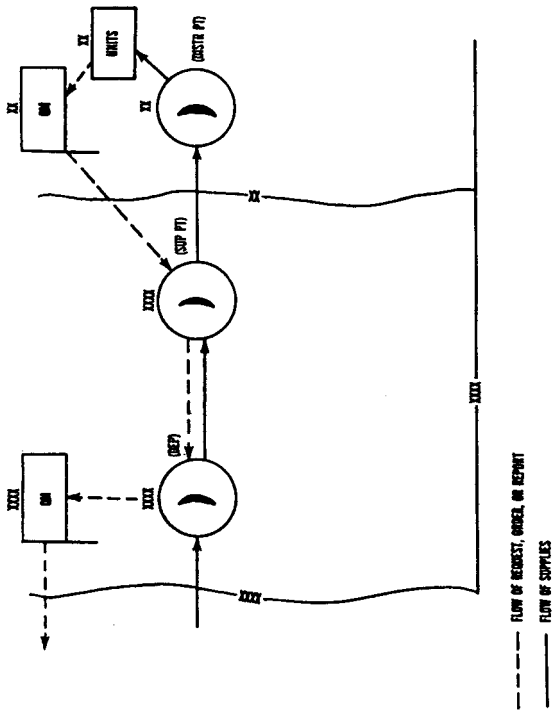

Figure 15. Requisition and flow of quartermaster class I supplies in divisions (schematic).

circumstances, subordinate units of the division, particularly flank groups, may draw direct from army class I supply point or pick up rations at such place as may be directed. This procedure will occur under the following circumstances:

a. When the division has not established a class I distributing point.

b. When a division unit of company size or larger is located at a distance from the division distributing point but near the army supply point.

42. Distributing Supplies to Units

a. *Infantry Division.* Under normal situations, class I supplies are delivered to major division units. After supplies have been delivered to the division class I distributing point by army transportation, personnel of the division class I section of the supply platoon prepare the supplies for delivery to using units on trucks of the division transportation battalion. For this purpose, the class I section will require approximately 15 cargo trucks each day. When unit distribution is not economical or feasible due to the tactical situation, supply point distribution may be accomplished within the division.

b. *Armored Division.* Under normal conditions, division class I distributing point receives supplies from the army class I supply point. Unit distribution is made in the division on vehicles organic to the armored quartermaster supply company. As frequent changes in organization of the division for combat or defense will require changes in supply procedure, it may be necessary

to change from unit to supply point distribution or to establish distributing points to support each combat command.

c. Airborne Division.

- (1) *Garrison.* In garrison, or when operating in the departure area, class I supplies are distributed within the division by the airborne supply and transportation company.
- (2) *Airhead.* Airborne units making the assault will carry a 3-day supply of assault and individual combat rations. So far as possible, assault forces will be resupplied by direct air transportation from the departure area. If distributing points have been established, supplies received will be broken down and delivered to major division units by the airborne supply and transportation company by unit distribution or supply point distribution or a combination of both.

43. Distributing Supplies Within Units

a. Large Units. Groups and battalions normally operate breakdown points for their organic and attached units. Group and battalion supply sections break down and deliver to unit kitchens.

b. Separate Units and Attachments. Separate companies and attachments not integral or attached to groups or battalions are supplied directly from the division class I distributing point. For transport economy, one separate or attached unit

may receive class I supplies for other like units in its area. Each separate or attached unit ration request is submitted individually to the division quartermaster or airborne division supply officer and the division distributing point is responsible for breakdown and delivery to such units.

Section V. APPORTIONING BULK SUPPLIES

44. General

To facilitate check-in and breakdown at the division class I distributing point, bulk supplies are loaded at the army supply point by item, and should be unloaded at the division class I distributing point in the same way.

45. Equipment and Supplies

a. Commissary Outfit. The class I section is provided with an organic commissary outfit including adequate equipment for apportioning bulk supplies.

b. Expendables. Paper for wrapping meat, paper bags for repacking broken lots of dry supplies, and similar expendable operating items are requisitioned through normal class II and IV supply channels.

46. Apportionment Procedures

a. General. Apportionment of class I supplies requires that—

- (1) When possible, bulk supply allotments to each organization be complete.
- (2) Bulk items be unloaded at a location providing sanitary and protected conditions during weighing and dividing.

(3) Bulk packages will be broken only to the extent necessary to accomplish equitable apportionment of items. Larger organizations should be able to draw their allotment of bulk items in the original packages.

b. Canned Goods. The can is the usual unit of issue. Cases will be broken down for distribution by can. Shortening, coffee, or powdered milk will be handled as dry supplies.

c. Dry Supplies. Broken and repackaged lots of dry subsistence items should be marked with weight, item, and unit for which intended.

d. Cased Fresh Meats. Refrigerated fresh meats are usually boned and packed 40- to 50-pounds per case. Each case is marked to show weight of contents. Individual cuts of meat are separately wrapped. Cased meats are handled in the same way as canned goods. Cases will be broken when necessary and individual cuts distributed.

e. Carcass Meats. Carcass meats are drawn as bulk from army supply points and cut by the meat cutter of the division class I section as apportioned for issue. Records of cuts issued should be kept so as to equalize distribution of more desirable cuts among division units.

f. Overissues and Underissues. Overissues and underissues of bulk class I supplies occur when packages received at the division distributing point are not the unit of issue, and when conditions do not permit proper apportionment.

Section VI. BREAKDOWN AND ISSUE

47. Truck-to-Truck Issue

Truck-to truck issue is the direct transfer of items from trucks containing incoming supplies to those which transport the supplies to the using or supported units. This method saves labor and handling. It keeps supplies under cover. It permits the class I distributing point to retain mobility and dispersion for security against attack. Supply trucks can rendezvous with supported units by map coordinates, day or night, and with supply columns during movements. This method is especially effective when the trucks transporting supplies to major units are available at the distributing point on the arrival of the army supply trucks. Its advantage is that no preliminary unit or item-pile breakdown is required. A disadvantage is the increased possibility of error and difficulty of issue control.

48. Breakdown

When truck-to-truck issue cannot be accomplished, personnel of the class I distributing point perform a preliminary breakdown by either of two methods. The supplies may be unloaded into unit or item piles.

49. Breakdown Methods

a. Unit Pile. Under the unit pile method, each item of class I supply is divided into as many piles as there are units to be supplied (fig. 16). Primary consideration should be given to the use of this method when a breakdown is required.

(1) *Procedure.*

- (a) Personnel of the class I section place unit signs at intervals around the breakdown area.
- (b) Clerical personnel of the class I section have the master ration breakdown sheet and unit ration breakdown sheets. If the breakdown is to be done directly from incoming trucks, ration breakdown worksheets will also be required. A copy of the division ration breakdown sheet provided by the army supply point will also be available.
- (c) The driver of each loaded truck coming from the supply point delivers to the ration distribution supervisor a truck slip covering the contents of his truck.
- (d) The ration distribution supervisor checks the master ration breakdown sheet against the statement of supplies received from army and makes the necessary corrections on breakdown and unit issue forms. These corrections are coordinated with the supply section, office of the division quartermaster or airborne division supply officer.
- (e) A checker, provided with a ration breakdown worksheet for the items carried as indicated on the load slip, is assigned to each incoming truck. Two

supply handlers are also assigned to each truck to assist in the breakdown.

- (f) Trucks stop at each unit sign, and the allowance of the item due the unit is unloaded. When all trucks have made the circuit, each unit pile is complete.
- (2) *Issue.* To avoid confusion, breakdown should be completed before issue begins. Vehicles to transport supplies to units should be routed through the breakdown area so as to eliminate the necessity for passing or retracking. The checker's copy of the unit ration breakdown should be signed by the truck driver and delivered to a representative of the receiving unit.

b. Item Pile. Under the item pile method, class I supplies are divided into as many piles as there are items of issue (fig. 17).

- (1) *Procedure.* Supply personnel at the distributing point have the master breakdown sheet and unit ration breakdown sheets.

- (a) Incoming supplies are checked against the master breakdown sheet and necessary corrections made. No truck slips are required for the breakdown.
- (b) Men are assigned each truck to unload, carry, and stack supplies at the item piles.
- (c) As supplies are unloaded, they are inventoried and sorted by item, in cans, pounds, or packages. A separate pile is

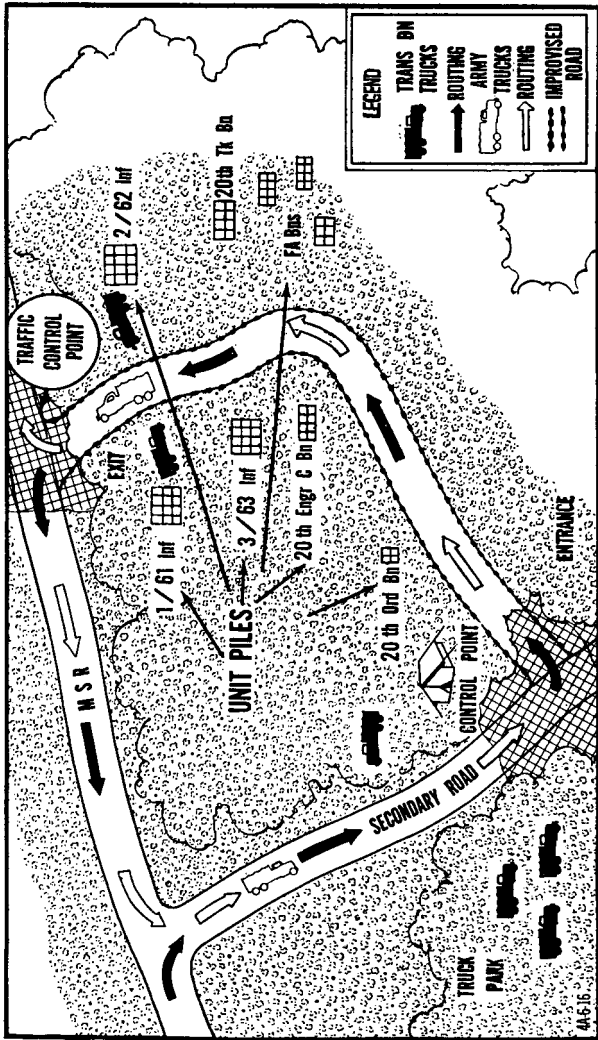

Figure 16. Unit pile method of breakdown.

made for each item. Minor items can be grouped together in several small piles.

(2) *Issue.*

- (a) A checker is assigned to each truck when it enters the breakdown area.
- (b) Each truck stops at each item pile to load the unit allowance. A ration breakdown worksheet may be used to facilitate issues.
- (c) The checker retains the duplicate of the unit ration breakdown sheet as a receipt.

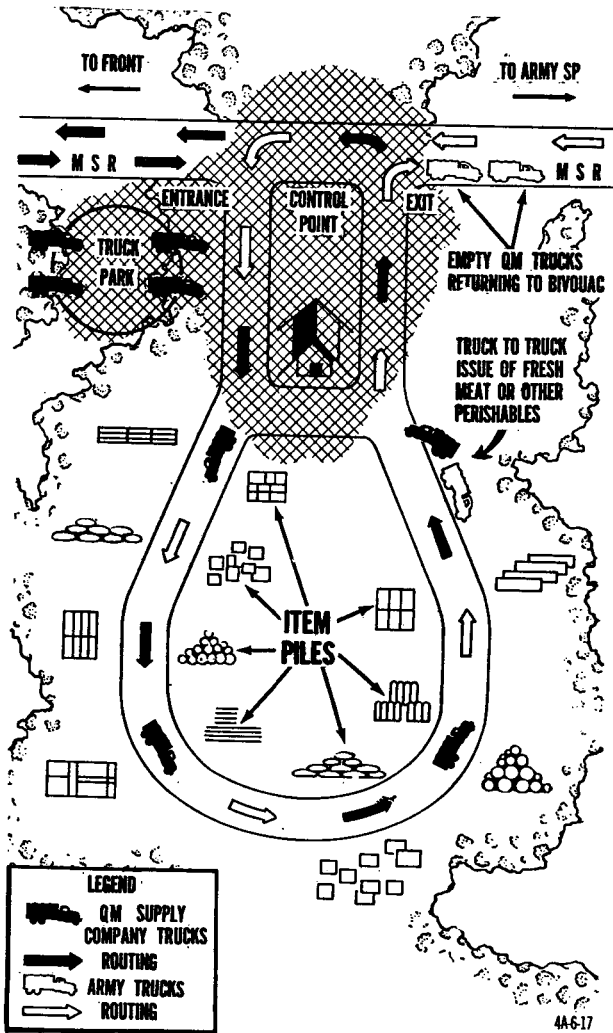

Figure 17. Item pile method of breakdown.

CHAPTER 5

CLASS II AND IV SUPPLY OPERATIONS

Section I. GENERAL

50. Definitions

Class II and IV supplies are items of supply and equipment issued to individuals or units.

a. The term *class II* is used to designate such of these items for which allowances are prescribed by tables of organization and equipment (TOE's), tables of allowances (TA's), equipment modification lists (EML's), or other written authority.

b. The term *class IV* is used to designate such of these items for which prescribed allowances have not been established and items which must be issued on special authority only. Items equivalent to army exchange supplies, when handled by the division quartermaster because army and air force exchange facilities are not available, become class IV supplies. Other typical quartermaster class IV items may be special cold-weather clothing for use in a special operation or items in excess of those authorized by TOE's, TA's, EML's, or other written authority.

c. Within divisions there is no difference between quartermaster class II and class IV supply operations, except for the requisitioning procedure. The issue of class IV items must be approved by the division quartermaster (airborne division supply officer) or higher headquarters.

51. Characteristics

Within the division, quartermaster class II and IV supply operations constitute a problem of re-supply rather than a problem of initial issue. Moreover, the operational characteristics of the divisions themselves preclude the establishment of hard-and-fast procedures for the distribution and issue of quartermaster class II and IV items.

a. Requirements Factors. Class II and IV supply requirements are periodic and are affected by the following factors:

- (1) Seasonal changes, which require that the needs for summer or winter uniforms, tent heaters and other seasonal items be anticipated. Unit reports on seasonal change requirements will be forwarded as directed by administrative orders and generally from 90 to 120 days in advance of need.
- (2) Increased needs preparatory to certain tactical movements and for the refitting of units after combat.
- (3) Regulation of items in short supply.
- (4) Relatively long interval between time of initiating requisitions and receiving the requested supplies.

b. Supply Factors. Class II and IV supplies present an item problem and must be specially requisitioned for one or more of the following reasons:

- (1) Substitutions cannot be made. Many items have no acceptable substitute.

- (2) Clothing and some items of individual equipment must be ordered by sizes.
- (3) Distribution of scarce items is normally subject to additional controls by higher headquarters.
- (4) The loss rate, consumption rate, or wear-out period for most class II and IV items is neither uniform nor predictable.

c. Reserves. Under the principles of selective stockage (par. 52), the purpose of the division class II reserve is to provide an insurance stock to meet emergency needs. In the infantry division, the reserve is carried on trailers of the division transportation battalion. In the armored division, it is maintained and transported by the armored quartermaster supply company. In the airborne division, it is maintained and transported by the airborne supply and transportation company.

- (1) The class II reserve is normally determined by army headquarters and announced in army orders in terms of prescribed levels. In some tactical situations, such as assault operations, maintenance of this level is mandatory. If not, the division commander may determine and prescribe the level within the limits of army authorization. In such cases, G4 will normally contact the division quartermaster or airborne division supply officer for recommendations.
- (2) The division reserve will include clothing suitable to the climate and certain items of individual equipment, such as blankets

or sleeping bags, listed in TA 21. In the infantry and armored divisions, the reserve may also include certain high-mortality repair parts, such as gaskets for water cans and food containers; generators, mantles, and globes for gasoline lanterns; cleaners, generators, and parts for field ranges. In the airborne division, stockage of these repair parts is the responsibility of the airborne maintenance battalion.

- (3) The reserve is maintained on the basis of items and sizes in demand. All echelons will insure that excessive reserves are not held to cover inefficiency in the supply system.

52. Controls

The issue and distribution of class II and IV supplies are subject to controls necessitated by the characteristics of these classes of supply and by the principles of supply economy. Stockage must be controlled to provide maximum service with minimum stocks. Issues must be controlled to insure distribution to proper units and organizations in accordance with established allocations and priorities. Stock control must be maintained as an essential element of supply management.

a. Selective Stockage. Selective stockage is the process whereby authorized stockage lists are developed on the basis of actual usage experience. Such lists, resulting from continual review and analysis of demand data, are modifications made by theater, army, or division commanders to allo-

cations prescribed by TOE's and TA's to meet requirements of specific tactical or logistical situations.

b. Issue Control. The principal means of issue control are regulated items lists and command-controlled items lists.

(1) *Regulated items lists* are published by the Department of the Army to control and supervise the issue and distribution of items in short supply and items that are costly or of a highly technical or hazardous nature. Requests for items appearing on a regulated items list must be processed through command channels, and items may be deleted from such lists by the Department of the Army only.

(2) *Command-controlled items lists* are published by commanders at all echelons to control and supervise issue and distribution of locally critical items. Requests for items appearing on command-controlled lists must be processed through command channels, and items may be deleted from such lists only by the command which published the list.

c. Stock Control. Unless specific stock accounting procedures are prescribed by higher headquarters, an informal system is established and maintained within the division. Basic records for this purpose include—

(1) Copies of documents covering delivery of supplies from army supply point or depot.

- (2) Copies of unit turn-in or issue slips for supplies issued to units.
- (3) Copies of unit turn-in or issue slips held pending receipt of the requested item from supply point or depot (suspense file).
- (4) A record book or card index file, by item, of the supplies required for maintenance. This will also show the current status of organizational items in the division. Unfilled requisitions in the suspense file will reflect latest requirement information.
- (5) Inventory of items in division reserve.
- (6) All pertinent authorizations and directives controlling the request and distribution of supplies, issue schedules, and related information.
- (7) Turn-in or issue slips or other prescribed records to cover the operation of the division salvage collecting point.

Section II. REQUISITIONING PROCEDURES

53. General

a. The system for requisitioning quartermaster class II and IV supplies will be established by standing operating procedures or administrative orders from division headquarters in accordance with the provisions of AR 735-35. The system will be adapted to requirements arising from the deployment of the division and the nature of the tactical operations. Under combat conditions the processing of requisitions at all echelons is made

as expedient as the situation and the availability of resources will permit, commensurate with adequate supply control.

b. To the extent practicable, requisitions for quartermaster class II and IV supplies may be electronically transmitted and necessary recording of the transactions maintained for stock control purposes by automatic data processing equipment. When the use of such equipment necessitates deviation from established procedures, such deviations must be approved by appropriate authority. Normally, deviations which violate the principles of selective stockage or the accumulation of demand data will not be allowed.

54. Infantry and Armored Divisions

The Request for Issue or Turn-In, DA Form 1546, is the basic form used for the formal requisitioning of quartermaster class II and IV supplies, including repair parts. This form is a single line-item requisition which is normally forwarded through supply channels without consolidations. Division or higher headquarters may, however, require consolidation by the division quartermaster. When the form is used to requisition replenishment of authorized class II items and quartermaster repair parts on authorized organizational stockage lists, it constitutes a justifiable requirement and an appropriate demand for which no further authorization is needed.

a. Class II Supplies.

- (1) Requisitions for class II supplies are submitted to the Supply Section of the Office

of The Division Quartermaster as scheduled by the division quartermaster. Upon receipt, the supply section—

- (a) Edits the requisition for stock number, item description, and authority.
 - (b) Makes necessary corrections by immediate and informal communication with the supply office concerned.
 - (c) Directs the II and IV Section of the Supply Platoon to make issue of requested items, if in stock.
 - (d) Assembles and consolidates, when appropriate, and forwards requisitions direct to the army class II and IV depot or the class II and IV section of a designated army depot (fig. 18).
- (2) Upon receipt of the supplies, the class II and IV section of the supply platoon makes delivery and/or issue to the unit or organization as required.
 - (3) In the event certain items cannot be immediately provided, the supply section of the Office of the Division Quartermaster sets up a back order system. The requisition is placed in a suspense file, and the requesting unit or organization is advised of the due-out, with notification that the supplies will be issued when available.
 - (4) A formal requisition is not used for the requisitioning of class II supplies when the direct exchange of unserviceable for

like serviceable items is possible. Direct exchange is the preferred method of re-supply in the case of mechanical equipment, since this procedure allows un-serviceable equipment to be available promptly for repair or recovery of essential parts. This direct exchange is made with the supporting quartermaster field maintenance direct support unit.

b. Class IV Supplies.

- (1) Upon receipt of a requisition for class IV supplies, the supply section of the Office of the Division Quartermaster evaluates and, as appropriate, assembles for forwarding to the army quartermaster for approval (fig. 19).
- (2) Upon receipt of the supplies, the class II and IV section of the supply platoon makes delivery and/or issue to the requesting unit or organization as required.
- (3) As in the case of quartermaster class II supplies, the supply section of the Office of the Division Quartermaster sets up a back order system for class IV supplies that are not immediately available.

c. Regulated and Controlled Items. As the issue of regulated and command-controlled items is governed by allocations and priorities, requisitions for such items must be forwarded through command channels (fig. 20). Division G4 or other authority prescribed by the division commander can approve requisitions for items appearing on

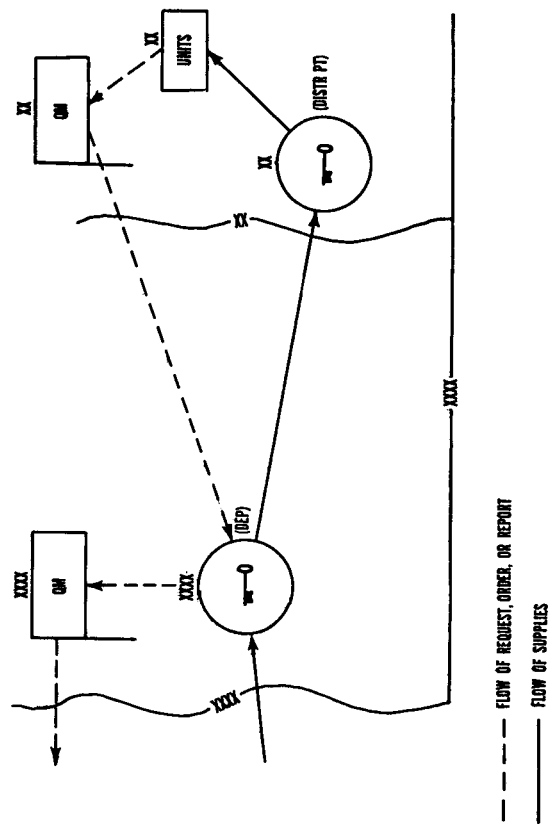

Figure 18. Requisition and flow of quartermaster class II supplies in infantry and armored divisions (schematic).

44618

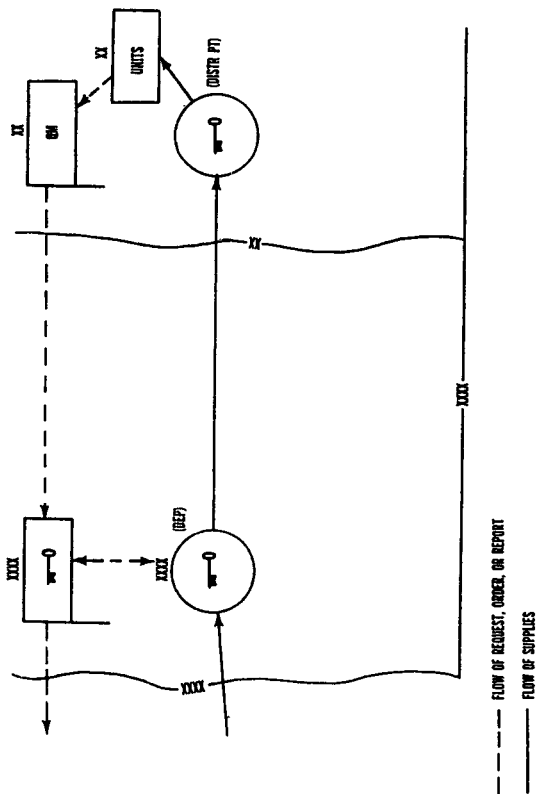
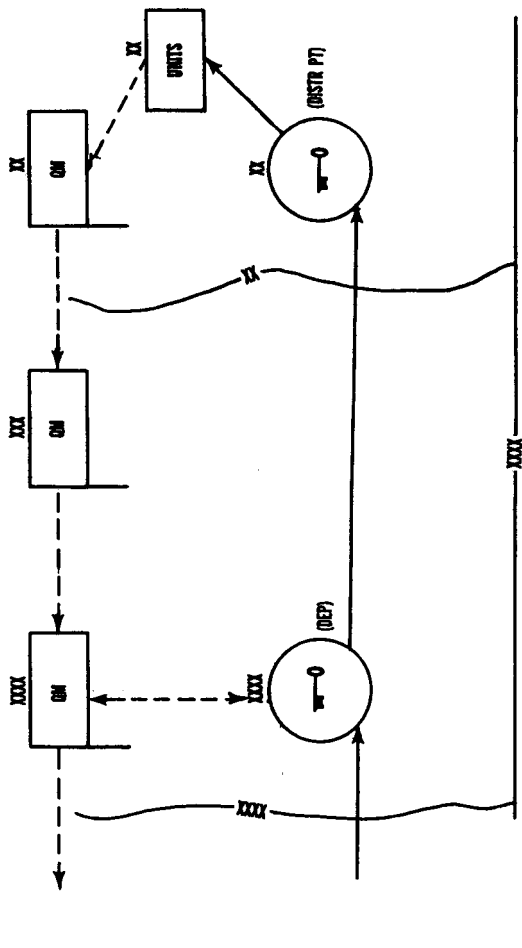

Figure 19. Requisitions and flow of quartermaster class
IV supplies in infantry and armored divisions
(schematic).



44-620

Figure 20. Requisitions and flow of quartermaster regulated items in infantry and armored divisions (schematic).

the command-controlled list published by the division commander. Requisitions for regulated items and items appearing on command-controlled lists published by higher headquarters must be submitted through the corps commander to the headquarters retaining control.

d. Quartermaster Repair Parts. The division quartermaster, charged with the technical supervision over maintenance of quartermaster equipment in the division, controls the supply of quartermaster organizational repair parts to using divisional units.

(1) In exercising this supervision, the division quartermaster—

(a) Prescribes the authorized organizational stockage list of quartermaster repair parts. This list implements the principle of selective stockage of quartermaster repair parts at division level by limiting stockage, within allowances prescribed by Department of the Army technical and supply manuals, on the basis of actual demand data. The criterion for stockage is normally expressed as a given number of demands within a specified number of days.

1. Authorized stockage at the organizational level is limited to fast-moving, high-mortality repair parts for which there is frequent demand.
2. Limited quantities of less-frequently demanded repair parts are stocked,

for insurance purposes, by supporting quartermaster maintenance units, which also maintain replenishment stocks of the same repair parts authorized for using organizations.

- (b) Approves requisitions for quartermaster organizational repair parts and coordinates supply of these parts to using unit.
- (2) Requests for quartermaster repair parts are submitted to the division quartermaster supply section.
- (a) The supply section of the Office of the Division Quartermaster normally assembles and transmits requisitions for repair parts to the designated quartermaster field maintenance direct support unit.
 - (b) These requisitions will be filled, if possible, from the insurance stocks maintained by the direct support unit. When the parts are not available for immediate issue, the direct support unit, places the requisitions in suspense and returns the due-out copy of the requisition to the requesting unit through the division quartermaster. When the repair parts are supplied, the class II and IV section of the supply platoon makes delivery and/or issue.

55. Airborne Division

a. Garrison. In garrison or while mounting, the airborne division will normally be logistically

dependent upon the base communications zone logistical command.

- (1) The division G4, as staff planner for all logistical operations affecting the division, will have primary interest in developing detailed plans and policies for adequate support of the operation and for coordinating support rendered during the mounting phase. In this connection, he will provide the appropriate supporting logistical command information as to—
 - (a) Supply requirements, including those necessary during marshalling as well as those to accompany units into the objective area and to be delivered to the objective area subsequent to the assault.
 - (b) Necessary nondivisional transportation requirements needed to move personnel, supplies, and equipment from camps or bivouacs to departure sites.
 - (c) Other administrative assistance, including storage facilities for individual clothing and equipment, and organizational equipment not needed in the objective area, additional technical service teams for inspections; and additional materials-handling equipment.
- (2) The airborne division support group commander, in his role as logistical operator of the division, will coordinate closely with G4 in the determination of

these requirements and in preparation of the division logistical plan and order.

- (3) During marshalling, divisional units will submit requisitions for class II and IV Supplies to organization S4's. Subject to the procedures specified by the division commander and the controls and conditions outlined in paragraph 52, the requisitions may be assembled or consolidated and forwarded to the division supply officer for submission to the appropriate supply officer or facility of the supporting agency. As much of the division's organic transportation is unavailable during this period for in-garrison support purposes, the division supply officer will normally arrange for unit distribution from the supporting agency supply facility direct to the organization S4. If the requests were consolidated by the S4, a breakdown will be necessary. If the requisitions were assembled, delivery may be made direct to requesting units.
- (4) Requirements for class II and IV supplies to accompany assault forces and to be delivered to the objective area as part of the followup will normally be determined by the division G4 and airborne support group commander on the basis of anticipated daily demands. So far as possible, accompanying supplies will be issued to units prior to marshalling, the desired quantity being that deemed suffi-

cient to sustain operations for approximately three days. Items to be included in the followup will normally be prepackaged for delivery by parachute, air landing, or free fall.

b. Airhead. In the airhead, class II and IV supplies are delivered, as part of followup supply, on an automatic preplanned basis or on call. A limited stock of selected class II items may be held in a distributing point in the objective area. When routine supply procedures are initiated, divisional units will normally submit requisitions to the representative of the airborne division supply and transportation company at the DLCC. The requisitions may be assembled or consolidated at the DLCC and transmitted to the appropriate supply agency. Requisitions for regulated and command-controlled items will be submitted through command channels.

Section III. DISTRIBUTION

56. General

The distribution of quartermaster class II and IV supplies in infantry and armored divisions is illustrated in figures 18, 19, and 20. The unit distribution method will normally be used; but, in certain instances, it may be more practicable to employ the supply point method or a combination of the two. Similarly, when the situation dictates, the division quartermaster may arrange for direct depot issue to using units.

57. Infantry and Armored Division

a. Infantry Division. In the infantry division, quartermaster class II and IV supplies are distributed by vehicles of the division transportation battalion. The quartermaster class II and IV reserve is carried on trailers of the division transportation battalion and issued by the division quartermaster as required to meet emergency needs.

b. Armored Division. In the armored division, quartermaster class II and IV supplies, including the division reserve, are normally distributed by the quartermaster supply company, armored division quartermaster battalion. Class II and IV distributing points, if established, will normally be located in the division trains area.

58. Airborne Division

Within the airhead, the division will normally be supported by direct supply to battle groups by aerial delivery or air landing. The supplies so delivered may be provided on a preplanned, automatic basis or they may be provided on a specific request basis initiated through the DLCC. If necessary, distributing points may be established to maintain the division reserves and supply those organizations without landing strips or drop zones. From these points, class II and IV supplies may be distributed by unit or supply point distribution or a combination of both.

CHAPTER 6

CLASS III SUPPLY OPERATIONS

Section I. GENERAL CHARACTERISTICS

59. Definition

Class III supplies consist of petroleum products including gasoline, kerosene, diesel oil, fuel oil, lubricating oil, and greases, except those used for medical purposes, for operating aircraft, and for use as ammunition in weapons. Class IIIA supplies are fuels and lubricants used in operating aircraft.

60. Influence of Bulk Distribution

Pipelines, rail tank cars, barges, and tank trucks are used to transport bulk class III supplies as far forward as practicable. Air delivery will be utilized to effect supply of petroleum products when ground supply routes are not secured or when the tactical situation demands.

a. Armored and Infantry Divisions. Rapid and flexible bulk distribution of petroleum is accomplished by 5,000-gallon semitrailers and 1,200-gallon tank trucks. In the infantry division this equipment is organic to the quartermaster company alone. In the armored division it is organic to major combat units as well as to the armored division quartermaster battalion. Because the equipment can also be used for mobile storage, the division quartermaster is able to use the trucks

and semitrailers under his control to maintain an easily committed supplementary operating stock rather than an on-the-ground reserve of packaged products.

b. Airborne Division. The tactical employment of the airborne division requires that petroleum products be supplied and distributed in containers. The normal level of class III supplies for the division in an assault is the amount required to move the division 100 miles cross-country. The airborne division supply and transportation company maintains approximately 5,000 gallons of gasoline in 5-gallon cans. Additional containers are required to sustain operations and will normally be requested through class IV supply channels.

Section II. SUPPLY REQUIREMENTS

61. Basis

a. Division Requirements. Division class III and IIIA requirements are calculated by the division quartermaster or airborne division supply officer.

b. Unit Requirements. Unit requirements are determined principally on the basis of the unit mile which is the amount of gasoline required to move all vehicles of the unit one mile. The division quartermaster or division supply officer maintains current records of this information together with daily records on quantities of petroleum required to maintain each unit during static phases. When unit estimates are not available for a specific operation, this information will provide a

basis for independent computations at division level.

62. Computations

a. The unit mile is determined by considering the following factors:

- (1) Type and number of vehicles.
- (2) Distances to be traveled.
- (3) Needs for kitchens and other administrative activities.
- (4) Weather, roads, terrain, and general operating conditions.
- (5) Wastage.

b. Specific information on the several types of vehicles is contained in FM 101-10 and FM 10-13.

63. Lubricant Requirements

Requirements for engine oils, gear oils, and greases vary with the number and types of vehicles operated, operating conditions, and temperature. They are calculated as a percentage of the gasoline requirement.

Section III. REQUISITION

64. Requests

The formal request for class III and IIIA supplies is the daily petroleum request, which indicates estimated requirements for the ensuing consumption period. The division request will normally include information as to stocks on hand.

a. The division estimate is the basis of information to army supply agencies as to the amount and kind of class III and IIIA supplies required.

- (1) If the division class III and IIIA requirements greatly exceed original estimates, supplemental requests will be submitted.
- (2) If unit class III and/or IIIA requirements are in excess of stocks on hand or available at army, the division quartermaster or airborne division supply officer will determine from the general staff sections the proposed operation of the divisional units to establish priorities of issue and will allot the available stocks to the units to be actively engaged.

b. The level of class III and IIIA supplies for the division is prescribed in Army orders. When an increase in the level is necessary to meet tactical demands, additional containers and additional transportation are required. As the trucks available for quartermaster supply operations are limited, augmentation of the class III supply level must include the command decision as to curtailment of other internal operations or the increase of transportation from sources outside the division.

65. Procedure

The division quartermaster or airborne division supply officer consolidates unit estimates and submits a division POL request to the appropriate Army class III supply point (fig. 21). Division requests are usually for supplies to be drawn from 1 to 3 days after submission of requisition.

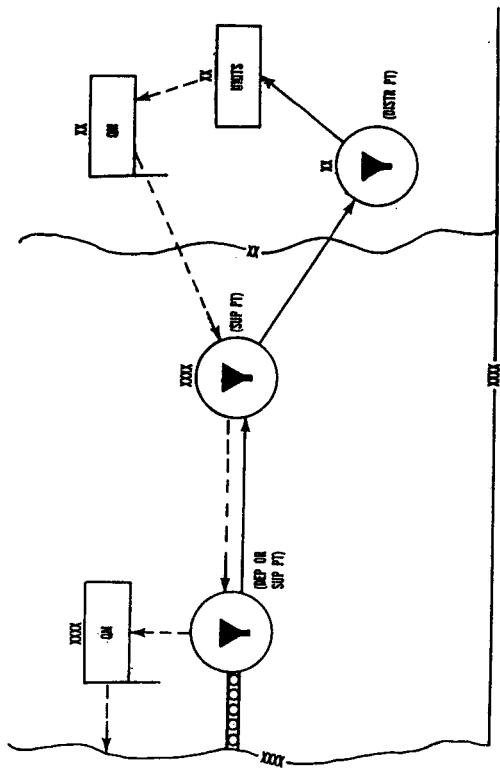

44-571

Figure 21. Requisition and flow of quartermaster class III supplies in division (schematic).

Section IV. DISTRIBUTION

66. Infantry Division

The class III section, infantry division, quartermaster company, is organically equipped with 1,200-gallon tank trucks and 5,000-gallon semi-trailers.

a. Allocation of Trucks. Normally 18 of the 1,200-gallon trucks are placed in direct support of the following units to take care of minimum daily requirements:

Aviation company	4
Engineer battalion	2
Division artillery	2
Infantry battle groups (5)	5
Armored battalion	3
Cavalry squadron	1
Transportation battalion	1

- (1) These trucks operate between the unit served and the class III distributing point. In event of increased unit requirements, additional tank trucks may be furnished by division. The division quartermaster is responsible for the maintenance of the tank trucks supporting the division units. When required by the mission or tactical operation of a unit, empty 1,200-gallon trucks may be exchanged for full ones to avoid delay.
- (2) The remaining 1,200-gallon trucks are used to supply the balance of the divisional units and to operate mobile filling stations and convoy refueling points. The trucks serving as mobile filling stations

are dispatched on schedule to specified unit areas.

b. Bulk Supply. Bulk supply is accomplished by the transfer of gasoline from the 5,000-gallon semitrailers to the 1,200-gallon tank trucks as close to the using units as practicable.

c. Packaged Products.

- (1) The use of packaged gasoline will be kept to a minimum, and will be carried in cans on trailers of the division transportation battalion and delivered to the division class III distributing point during bivouac.
- (2) Packaged gasoline is also used for continual resupply of the tank battalion and armored cavalry squadron. The quartermaster must arrange for continual resupply by 5-gallon cans in addition to the attached tank trucks. It is estimated that each of these units will require a shuttle service of three 2½-ton trucks and 1½-ton trailers to haul cans between the class III distributing point and the unit. The trucks and trailers for the shuttle will be provided by the division transportation battalion. Bulk distribution methods must be employed to the maximum before utilizing cargo type vehicles to transport POL products.

d. Lubricants. Grease and lubricating oils are supplied by army on demand. The division normally stocks these items in drums, cans, or pails.

Information as to the various types of containers for lubricants and greases authorized for military use is included in SB 38-5-3.

67. Armored Division

a. Bulk Supply.

- (1) The class III section, quartermaster supply company, armored quartermaster battalion, is also organically equipped with 5,000-gallon semitrailers and 1,200-gallon tank trucks. The 5,000-gallon semitrailers are used primarily to make bulk distribution of class III supplies by establishment of class III distributing points, delivery to combat command trains areas, or direct delivery to using units. The 1,200-gallon trucks are used to establish mobile filling stations along the main supply route in the vicinity of the division trains area to refuel the administrative and logistical vehicles.
- (2) To facilitate further bulk distribution within the major units of the division, 1,200-gallon tank trucks organic to combat and combat support battalions transport bulk class III supplies from the combat command trains area to company trains areas. When the dispersion of combat units and the tactical situation dictates, the class III section may establish forward mobile filling stations where committed combat commands may obtain class III supplies.

b. Packaged Products. The quartermaster supply company is provided with a stock of 5-gallon cans that are issued to replenish the supplementary operating stocks of all the divisional units. The cans may be issued on an emergency or a direct exchange basis or may be utilized for aerial resupply.

c. Lubricants. Lubricants and greases are supplied on demand in accordance with actual needs.

68. Airborne Division

During the assault phase and while operating in the airhead, fuel supplies may be delivered to the division in 5-gallon cans or 55-gallon drums by airdrop or air landing on a preplanned automatic basis. When facilities permit, fuel will be delivered into the airhead in bulk. In garrison or in marshalling areas, the class III supplies will be delivered to the division units by tank trucks from nondivisional supporting agencies. Packaged oils and lubricants will be delivered with the fuel.

Section V. CLASS III DISTRIBUTING POINT

69. General

The site for the division class III distributing point will be selected in accordance with the general requirements discussed in paragraphs 21 through 23. When more than one distributing point is established, locations will be announced and units to be supplied from each will be listed.

a. Layout.

- (1) The site should be reasonably level and well drained to prevent water damage.

- (2) Depressions should be avoided to prevent danger of vapor collection.
- (3) Sites may be in low hills or in rolling country if the stocks are properly dispersed. Sites should not be uphill or upstream from other installations which would be in the flow of escaped flammables.
- (4) Natural concealment should be exploited when available.
- (5) Nearness to water is an advantage in fire control.
- (6) Combustible buildings should be given a minimum clearance of 250 feet.
- (7) A control point should be established on the route of incoming and outgoing traffic and at a safe distance from handling areas.

b. Storage. When packaged petroleum products must be stored, stacking procedures outlined in TM 10-1101 will be adapted to the local situation.

70. Precautions

a. Containers.

- (1) All containers will be carefully inspected at the distributing point and, if necessary, evacuated to army for cleaning or repair.
- (2) Leaking containers will be decanted immediately and contents issued for local use.

b. Contamination. Petroleum products are readily contaminated by dirt, rust, water, gum,

or contact with other products or grades. Care to avoid such contamination is vital to preserve the products for their intended purposes.

c. Fire.

- (1) No fires will be built or matches lighted in the vicinity of gasoline stocks.
- (2) Smoking will be prohibited. When civilian labor is employed to handle petroleum, NO SMOKING signs, in a language understood by the civilians, will be prominently posted.
- (3) Gasoline that has spilled or leaked upon the ground will be covered at once with sand or dirt.
- (4) Waste or oily rags will not be allowed to accumulate in the storage areas.
- (5) Containers will be kept closed whether full or empty.
- (6) Flashlights other than vaporproof type should be kept away from containers.
- (7) Containers will be placed on the ground for filling. Nozzles will be kept in constant contact with the container. If containers must be filled on trucks, the trucks will be properly grounded.
- (8) A petroleum fire-fighting plan will be established and published in the standing operating procedure for the class III distributing point. All personnel will be trained in fire fighting, and fire drills will be frequent to assure familiarity with the fire-fighting plan.

d. Personnel.

- (1) Because of the toxicity of gasoline fumes, handling personnel will be rotated at frequent intervals, if possible.
- (2) Handling personnel will wear leather gloves treated with leather dressing or other gasoline resistant substance. Boots will be free of metal plates and nails.
- (3) Leaded gasoline will not be used for cleaning purposes.

CHAPTER 7

CLASS V SUPPLY OPERATIONS

71. General

Class V supply is ammunition of all types except nuclear devices. It includes explosives, anti-tank and antipersonnel mines, fuzes, detonators, pyrotechnics, and chemical agents.

72. Airborne Division

In the airborne division, class V items are supplied by the class V section of the airborne supply and transportation company.

a. Responsibility. This section is under the command of an ammunition supply officer (ordnance). When the division class V supply point is established in the airhead, the class V section—

- (1) Submits reports on required ammunition supply rates.
- (2) Maintains records and data on the available supply rate.
- (3) Authenticates all ammunition requests.
- (4) Supervises explosive ordnance disposal service.

b. Procedure. During the assault phase, ammunition is supplied automatically on the basis of estimated requirements. Replenishment of expenditures in excess of those planned will be by direct air delivery to battle groups and division

artillery elements. When routine supply procedures are established, using units transmit their class V requirements to the division ammunition supply officer at the division class V distributing point when established. The division ammunition officer will advise the DLCC of all ammunition requirements so that expenditures can be compiled and transmitted to the appropriate supply agencies.

c. Rocket Ammunition. Missile batteries employ supply point distribution, using organic transport vehicles.

d. Reserves. The procedures for the supply of class V are vastly different than for other classes of supply. Reserves, as such, are not maintained. Basic loads are maintained at prescribed levels (FM 101-10). These are designated by unit for each operation and are based on—

- (1) Anticipated opposition.
- (2) Number and type of weapons.
- (3) Timelag between landing and availability of followup supplies.
- (4) Number and type of aircraft available.
- (5) Experience factors developed from prior operations.

73. Armored Division

Quartermaster responsibility for class V supply in the armored division is limited to providing cargo transportation to operate a division mobile class V distributing point when required (par. 11c(4)).

CHAPTER 8

SERVICE OPERATIONS

Section I. BATH

74. Responsibility

Bath facilities for personnel of the infantry and armored divisions are supplied by bath equipment organic to the infantry division quartermaster company and the armored division quartermaster battalion. The airborne division is entirely dependent on nondivisional support for this service.

75. Deployment of Bath Units

a. The bath units are usually deployed on the basis of one bath unit in support of each battle group or combat command and one bath unit in the division trains area.

b. In some situations, it may be more satisfactory to operate all units in combination. This combined operation allows closer supervision and control, provides uninterrupted service in case of mechanical failure in an individual unit, and requires fewer operating personnel.

76. Bath and Clothing Exchange Operations

Under active combat conditions division personnel will often be provided clean clothing at the bath facility. This will be done only at the direction of the division commander. The determination will be based on such factors as health, morale, com-

fort, and convenience. Such would be the case when division personnel are subjected to nuclear, chemical, biological, or radiological attack. When a clothing exchange operation is established, the division quartermaster must acquire the necessary clothing. Division units receiving the exchange service will be required to provide personnel at the bath point to guard personal effects, issue clean clothing, and collect and bundle dirty or contaminated clothing for disposition.

Section II. GRAVES REGISTRATION

77. Responsibility

a. Infantry Division. In the infantry division, responsibility for graves registration activities is assigned to the recovery and disposition platoon of the quartermaster company. The operations officer, office of the division quartermaster, is normally designated as division recovery and disposition officer and exercises staff planning and supervision over graves registration operations.

b. Armored Division. In the armored division, responsibility for graves registration activities is assigned to the recovery and disposition platoon, quartermaster field service company, armored quartermaster battalion. The purchasing and contracting officer, office of the division quartermaster, is normally designated as recovery and disposition officer, and exercises staff planning and supervision over graves registration operations.

c. Airborne Division. In the airborne division, the responsibility for graves registration activities

is assigned to the recovery and disposition section of the headquarters, headquarters and service company, airborne support group.

78. Organization

a. Armored and Infantry Division. In the armored and infantry division, the recovery and disposition platoon is organized into—

- (1) *Platoon headquarters.* Platoon headquarters is responsible for the coordination and operation of graves registration functions within the division.
- (2) *Division collecting, identification, and evacuation section.* The division collecting, identification, and evacuation section operates the division collecting point where deceased personnel are received from forward areas, examined for identification, and prepared for evacuation to an army collecting point or cemetery.
- (3) *Collecting and evacuation sections.* The collecting and evacuation sections operate in support of combat commands and battle groups. They are responsible for supervising evacuation of remains to the division collecting point.

b. Airborne Division. The recovery and disposition section in the airborne division consists of the section leader, recovery and disposition sergeant, and enlisted assistants who supervise graves registration activities of the combat elements. The

recovery and disposition section leader is the division recovery and disposition officer.

79. Graves Registration Service

At division level, grave registration activities consist principally of the receipt of remains from forward elements of the division, initial identification of the remains, and preparation for their evacuation by army recovery and disposition personnel. Division graves registration facilities are limited and must be augmented by nondivisional recovery and disposition personnel when the division sustains severe casualties.

a. The collecting and evacuation sections supporting the major combat units of the armored and infantry divisions will be principally concerned with the receipt and evacuation of remains to the division collecting point. These sections will assemble identifying media and personal effects and prepare the remains for evacuation. When the tactical situation permits, the sections, augmented if necessary by nondivisional personnel, may supervise search and recovery operations in the battle areas.

b. In the airborne division during the assault phase, the division recovery and disposition section operates the division collecting point where deceased personnel are received from the battle area, examined to verify identification, and prepared for aerial evacuation from the airhead to a designated collecting point or cemetery. After link-up, deceased personnel may be evacuated to army collecting points or cemeteries.

80. Procedures

a. *Unit Combat Area.*

- (1) Commanders of infantry and armored units are responsible for the recovery and evacuation of deceased personnel from the unit area in accordance with the procedure outlined in FM 10-63. Normally, combat personnel evacuate remains to battalion, group, or combat command collecting points by carrying parties or by empty supply vehicle. Personnel of the collecting and evacuation section verify or attempt to verify identification, and prepare the remains and personal effects for evacuation.
- (2) In the airborne division, battlefield search and preliminary identification of deceased personnel is a command responsibility. Units evacuate remains and personal effects from the battle area to group or division collecting points by any available transportation. When the airhead is secured and the position consolidated, the recovery and disposition section may assume this responsibility and organize and supervise search and recovery teams to operate in the combat group battle area.

b. Division Collecting Point. The division collecting point should be located so as to be accessible to all subordinate collecting points. It should be well removed from all other installations, and its operations should be concealed from passing traffic. At

the division collecting point, recovery and disposition personnel take and record fingerprints, take all possible steps to verify identification, establish and maintain a register of remains, assign evacuation numbers, inventory personal effects, and prepare remains for evacuation to army facilities.

81. Caring for Remains

Remains should be shrouded except when being examined by authorized personnel. All identifying media should be kept with the remains. Special care will be taken in case of partial recoveries to insure that identifying media are not lost.

82. Emergency Medical Tag

Normally, an Emergency Medical Tag (DA Form 8-26) will be prepared by medical personnel and attached to remains at the first collecting point. The tag will list, so far as possible, name of deceased, arm or service, branch, age, race, place of recovery, when and where tagged, and cause of death. The tag will be checked at each collecting point through which the remains are processed, verified, and protected from the chance of being obscured or obliterated in handling. If tags are not available, a note containing the essential information should be attached to the remains.

83. Tactical Information

If written information of tactical importance is found on or with any remains, it should be removed and delivered to the appropriate authority for disposition. A note to this effect should be attached to such remains.

84. Personal Effects

Money, wallets, jewelry, identification wristbands, and military decorations will be inventoried on Record of Personal Effects (DA Form 54), and attached to remains at the initial collecting point. Effects will be removed for inventory at the division collecting point, sealed in personal effects bag, attached to remains, and not again removed until the remains reach army facilities.

85. Identification Procedures

Identification of deceased personnel is a continuing process from recovery until positive identity is established. It begins at point of recovery and continues through all collecting echelons. Complete information on identification procedures is contained in TM 10-286 and FM 10-63.

a. Basic Requirements. The following points are most important to division recovery and disposition personnel in identification procedures—

- (1) Thoroughness and resourcefulness in examination of all possible sources of identity information.
- (2) Care in preservation of identification media.
- (3) Thoroughness and accuracy in preparation of forms and reports dealing with identification.
- (4) Use of interview method. Identification by an individual personally acquainted with the deceased should be obtained when possible.

b. Identification Media.

- (1) Army equipment and records that may be used to establish identity are clothing marks, pay records, identification tags, emergency medical tags, identification cards, weapons numbers, tank or vehicle numbers, morning reports, and rosters.
- (2) Personal effects include items listed in paragraph 84.
- (3) Additional sources of information may be provided by fingerprinting, interviews, and identification of other remains recovered with those unidentified.

86. Evacuation to Army Facilities

Remains are normally evacuated from division in transportation from army support units. Remains in transit should be shrouded and the back curtains of the transporting trucks closed. Evacuation routes should bypass troop concentrations and civilian areas. All pertinent records should be forwarded with the remains and a guard should accompany them.

Section III. SALVAGE, MAINTENANCE, AND CAPTURED MATERIEL

87. Salvage

Salvage is material that has become unserviceable or property that has been lost, abandoned, or discarded and recovered by a salvage organization. Salvage continues to be a responsibility of the supplying technical service as long as it may be economically repaired or modified for other use.

a. Responsibility. The division quartermaster or airborne division maintenance officer is responsible for the establishment of a division salvage collecting point for receipt and evacuation of salvage items and captured materiel. Division facilities for this service must be augmented by non-divisional support when large quantities of salvage or captured materiel are involved. Unit commanders are responsible for salvage collection and evacuation within their unit areas.

b. Collection and Evacuation. Prompt collection and evacuation of salvage render equipment and supplies available for reissue. Quartermaster equipment requiring repair will follow normal reclamation and maintenance channels before being declared salvage.

c. Procedures at Division Collecting Point. In the infantry and armored division, the division salvage collecting point is operated by personnel of the class II and IV section. It is normally located in the vicinity of the division class I distributing point. Salvage items are segregated by item and group. They are given a basic serviceability classification and, based on this and on current division requirements, further segregated into groupings for reissue within the division or evacuation to the appropriate supporting facility.

88. Maintenance

a. The infantry and armored division quartermaster implements field army plans and policies pertaining to the maintenance of quartermaster equipment. Operating through the supply section

of his headquarters, he exercises technical supervision of organizational maintenance of quartermaster equipment within the division. In the airborne division, maintenance of equipment is the responsibility of the Airborne Maintenance Battalion (TOE 29-65T). This battalion provides direct support field maintenance for all equipment within the division with the exception of quartermaster air-type items, which are a responsibility of the organic Airborne Quartermaster Parachute Supply Company (TOE 10-337).

b. Divisional units of the armored and the infantry division perform organizational maintenance to the extent authorized by Department of the Army publications and by theater, army, and division directives. Personnel organic to the infantry division quartermaster company and the armored division quartermaster battalion provide direct support of divisional units in maintenance of quartermaster field cooking, heating, and light equipment, and office machines.

89. Captured Materiel

Captured enemy supplies and equipment are handled in the same fashion as salvage materiel. Empty vehicles moving to the rear are utilized to transport captured materiel to establish salvage collection points of the appropriate service. Large quantities of materiel captured in warehouses or dumps in the division area will be placed under security until disposition is directed by G4.

a. *Examination.* Captured materiel is a source of information for technical intelligence operations.

Samples of new or unique quartermaster type supplies and equipment will be turned over immediately to technical intelligence (FM 30-16).

b. Use. Use of captured supplies by the seizing unit without authority of higher headquarters is justified only when the unit is cut off from its normal source of supply.

c. Captured Petroleum Products.

- (1) Samples should be forwarded by division to the quartermaster petroleum products laboratory for determination of adaptability to use in United States military service.
- (2) The laboratory will test the products for identification and application and, when necessary, send samples to a designated petroleum research laboratory for intelligence purposes.
- (3) Products will be disposed of as directed by higher headquarters.

Section IV. MISCELLANEOUS SERVICES

90. Aerial Supply

Aerial supply must be regarded as a principal supply method and must be integrated within the logistical system. The advent of mass destruction weapons makes the speed of aerial supply desirable: the effectiveness of new communications media and the improved capabilities of operational cargo aircraft make it practical. It can no longer be considered as merely an alternate or emergency means of alleviating supply deficiencies.

a. Methods. Supplies may be air landed or delivered from aircraft in flight by parachute drop or by free fall. Both methods provide a fast and effective means of supply delivery and present the following advantages:

- (1) minimizes the vulnerability of aircraft to enemy detection and destruction on the ground.
- (2) reduces the aircraft turn-around time.
- (3) eliminates the need for forward landing fields and reduces the number of service troops required to unload supplies in the objective areas.

b. Infantry and Armored Divisions. Personnel of the class II and IV section of the infantry division quartermaster company and of the quartermaster supply company, armored division quartermaster battalion, package and rig supplies for aerial delivery by division aircraft.

c. Airborne Division. Supply of parachutes for the division and technical supervision of packing, rigging, loading, and recovery of parachutes and related air-type items of equipment is the responsibility of the airborne quartermaster parachute supply company. General operating procedures for the company are contained in FM 10-33.

91. Laundry

Organic laundry facilities are not provided in the division. Laundry service is provided by non-divisional units under the operational control of the army quartermaster. Division receives tonnage allocations for laundry from the army quarter-

master and apportions them among division units. The division quartermaster or airborne division supply officer arranges laundry schedules with the army quartermaster and coordinates the laundry facilities made available for the division.

92. Food Service

Food service supervision in a division is performed by the division food adviser who is a member of the staff of the division quartermaster or the airborne division supply officer. The duties of the food adviser are to coordinate, assist, and advise on all phases of food management from procurement to serving, including the improvement of food preparation facilities. These duties do not alter the responsibilities of unit and organization commanders and others connected with the food program.

APPENDIX I

REFERENCES

- | | |
|-------------|---|
| AR 30-11 | Food Program. |
| AR 30-40 | Rations. |
| AR 220-70 | Companies—General Provisions. |
| AR 310-3 | Military Publications—Preparation and Processing. |
| AR 611-201 | Manual of Enlisted Military Occupational Specialties. |
| AR 643-55 | Disposition of Personal Effects: Military Operations. |
| AR 711-16 | Stock Control: Army Field Stock Control System and Related Supply Procedures. |
| AR 735-5 | Property Accountability: General Principles and Policies. |
| AR 735-35 | Supply Procedures for TOE Units, Organizations, and Non-TOE Activities. |
| AR 743-41 | Shed and Open Storage of Supplies. |
| AR 750-5 | Maintenance Responsibilities and Shop Operation. |
| SR 320-5-1 | Dictionary of United States Army Terms. |
| SR 35-715-1 | Vouchers Covering Payments to Native Civilian Employees. |

- SR 605-105-5 Commissioned and Warrant Officer Personnel Military Occupational Specialties.
- Pam 108-1 Index of Army Motion Pictures, Filmstrips, Slides, and Phonorecordings.
- Pam 310-1 Index of Administrative Publications.
- Pam 310-2 Index of Blank Forms.
- Pam 310-3 Index of Training Publications.
- Pam 310-4 Index of Technical Manuals, Technical Regulations, Technical Bulletins, Supply Bulletins, Lubrication Orders, and Modification Work Orders.
- Pam 310-7 Index of Tables of Organization and Equipment, Tables of Organization, Type Tables of Distribution, and Tables of Allowances.
- FM 5-15 Field Fortifications.
- FM 5-20 Camouflage, Basic Principle.
- FM 5-20A Camouflage of Individuals and Infantry Weapons.
- FM 5-20B Camouflage of Vehicles.
- FM 5-20C Camouflage of Bivouacs, Command Posts, Supply Points, and Medical Installations.
- FM 5-20G Camouflage of Rear Areas and Fixed Installations.
- FM 5-22 Camouflage Materials.

FM 5-25	Explosives and Demolitions.
FM 7-24	Communications in Infantry and Airborne Divisions.
FM 10-10	Quartermaster Service in Theaters of Operations.
FM 10-13	Quartermaster Reference Data.
FM 10-17	Quartermaster Organization and Service in Army and Corps.
FM 10-33	Airborne QM Parachute Supply and Maintenance Company.
FM 10-60	Supply of Subsistence in Theaters of Operations.
FM 10-63	Handling of Deceased Personnel in Theaters of Operations.
FM 10-64	Quartermaster Class II and IV Supply in Theaters of Operations.
FM 20-15	Tents and Tent Pitching.
FM 20-32	Employment of Land Mines.
FM 21-5	Military Training.
FM 21-10	Military Sanitation.
FM 21-11	First Aid for Soldiers.
FM 21-20	Physical Training.
FM 21-26	Map Reading.
FM 21-40	Defense Against CBR Attack.
FM 21-41	Soldiers Manual for Defense Against CBR Attack.
FM 21-48	CBR Training Exercises.
FM 22-5	Drills and Ceremonies.
FM 22-10	Leadership.

FM 24-5	Signal Communications.
FM 24-18	Field Radio Technique.
FM 25-10	Motor Transportation Operations.
FM 26-5	Interior Guard Duty.
FM 27-10	The Law of Land Warfare.
FM 30-15	Examination of Personnel and Documents.
(C) FM 30-16	Technical Intelligence (U).
FM 31-25	Desert Operations.
FM 31-70	Basic Arctic Manual.
FM 31-71	Operations in the Arctic.
FM 31-72	Administration in the Arctic.
FM 70-10	Mountain Operations.
FM 72-20	Jungle Operations.
FM 100-5	Field Service Regulations—Operations.
FM 100-10	Field Service Regulations—Administration.
FM 101-5	Staff Officers Field Manual: Staff Organization and Procedure.
FM 101-10	Organization, Technical, and Logistical Data.
DATC 3-2	Radiological Surveys.
TM 3-205	Protective Masks and Accessories.
TM 3-220	Contamination.
TM 3-290	Individual Protective and Detection Equipment.

TM 5-315	Fire Protection by Troop Organizations in Theaters of Operations.
TM 5-637	Inspections and Preventive Maintenance Services for Kitchen Equipment.
TM 9-2700	Principles of Automotive Vehicles.
TM 9-2800	Military Vehicles.
TM 9-2810	Tactical Motor Vehicle Inspections and Preventive Maintenance Services.
TM 10-401	The Army Food Adviser.
TM 10-405	Army Mess Operations.
TM 10-412	Recipes.
TM 10-1101	Petroleum-Handling Operations.
TM 10-632	Kits, Fingerprint.
TM 10-1103	Quartermaster Petroleum-Handling Equipment.
TM 21-300	Driver Selection and Training.
TM 21-305	Driver's Manual.
TB 11-1	Maintenance of Quality Standards for Aviation Fuels.
TB QM 27	Demolition of Quartermaster Supplies and Equipment.
TB QM 32	Conservation of Clothing, Equipment, and General Supplies.
SB 10-260	Master Menu.

- SB 38-5-3 List of Standard Lubricants, Hydraulic Fluids, Liquid Fuels, and Preventive Materials Used by the Department of the Army.
- TA 10-100 Allowances of Quartermaster Expendable Supplies.
- TA 21 Clothing and Equipment.
- Manual for Courts Martial, United States, 1951.

APPENDIX II

OPERATIONS UNDER UNUSUAL CONDITIONS

Section I. ARCTIC

1. General

Quartermaster troops of the division must be proficient in special techniques required for Arctic conditions. Some of the points requiring emphasis are—

- a.* Determination of supply requirements.
- b.* Special techniques of storage, camouflage, handling, issue, and delivery of supplies.
- c.* Establishment and operation of bath and laundry facilities.
- d.* Techniques of operation of quartermaster special equipment.
- e.* Graves registration activities.

2. Site Selection

a. General.

- (1) When operating in subarctic areas, forests provide the best sites for quartermaster installations such as distributing points and bath sites. Forests provide building materials, firewood, camouflage, cover, and concealment against enemy air and ground action. Coniferous forest areas provide the best protection against

winds and they also offer better building materials and firewood.

- (2) The site should afford maximum protection in all directions against surface attack.
- (3) The area should be as firm and as dry as possible.

b. Winter. The site for quartermaster installations should offer protection from wind and cold. It should be located near fuel, building materials, and water.

- (1) *Subarctic.* In the subarctic, forest areas should be used for installation sites. It may be necessary to drain the site by clearing creeks and digging ditches.
- (2) *Arctic.* Natural windbreaks should be used as much as possible. They may consist of depressions in the ground or pressure ridges on the ice. These also afford protection from drifting snow.

c. Summer.

- (1) The site should be convenient to rivers or other navigable water.
- (2) To give protection from insects, the site should be located near a lake, on a ridge, or in an area having an onshore breeze.

3. Estimating Supply Requirements

Estimates of requirements made in the office of the division quartermaster for supply needs in arctic areas must take into consideration variations from normal operating conditions.

a. Movement of Supplies. Movement of supplies is difficult in the subarctic winter. Wheeled vehicles will be limited to roads and prepared trails. Vehicles may be easily ambushed and delayed.

b. Larger Quantities Required. Larger quantities of supplies will be consumed in the Far North than under temperate climate conditions. Troops require increased ration allotments, additional clothing, and warmer shelter. Vehicles consume more fuel for operations.

c. Alternate Methods Required. Alternate means of supply must be provided. Supply by surface may be impossible and airdrop required.

d. Minimum Essentials. Only essentials can be moved. Units must never be burdened with supplies.

4. Transporting Supplies

a., By Air. Aircraft will be used frequently to move supplies in the Arctic and subarctic. Supplies may be airlanded or delivered by parachute or free drop.

b. By Roads. Roads are few and vulnerable to air attack, both in winter and summer. Wheeled vehicles can operate in snow up to 12 inches deep and should be used as much as possible. Tracked vehicles can be used to carry and tow supplies.

c. By Water.

- (1) In summer, barges and tugs can be used at sea and on rivers, and boats or rafts over lakes and streams. Rafts may be improvised from materials found locally.

- (2) In winter, frozen waterways often provide the best routes of transport. Aircraft can use frozen rivers and lakes for landing and takeoff.

d. Over Difficult Terrain.

- (1) Low ground-pressure, track-laying vehicles (amphibious) are especially suitable for cross-country transportation in Arctic and subarctic areas both in summer and winter.
- (2) The ahkio, or boatlike sled, is used in the Arctic and subarctic to carry loads of 100 to 200 pounds over difficult terrain. It can carry fuel, rations, and other necessary items at unit level. It is pulled by skiers or snowshoers and will slide easily over the track made by skis or snowshoes.
- (3) Flat-surfaced toboggans or sledges cannot be used as well as ahkios in deep snow or in thick woods.

5. Marking Supply Areas

All open supply areas in the Arctic should be defined and marked so that supplies will not be lost in inclement weather.

6. Storing Supplies

a. Snowy Areas. In snowy areas, supplies may be stored in snow caves, snow trenches, and snowhouses (igloos).

b. Cold-Wet Areas. In cold-wet areas, supplies should not stand on wet or damp ground which

may freeze, since they will be difficult or impossible to handle. Flooring or pallets of wood should be improvised. In periods of thaw or during summer, storage areas should be drained.

c. Use of Covered Storage. Items that are affected by extremes in temperatures must be put in heated covered storage.

d. Storing Perishables. During warm periods, cooler storage is needed for perishables. In permafrost areas, a hole can be dug or blasted out of the ground, perishables stored in it and covered with insulating material, such as boughs. Where there is no permafrost, a hole may be dug in the ground, the bottom covered with boughs or sawdust, and topped with a layer of ice blocks. Perishables can be placed on the ice and the hole covered with tree branches.

7. Class I Supply Operations

Division class I distributing points will obtain class I supplies from supporting supply points by means of surface or air transport.

8. Class II and IV Supply Operations

Class II and IV items are distributed in much the same way as class I items. Supporting supply points will be operated in subarctic areas and items forwarded to using units through normal division supply channels. Larger stocks of specialized clothing and equipment must be maintained by the division distributing point in Arctic climates than in temperate climates.

9. Class III Supply Operations

a. Products Distributed. Special petroleum products for Arctic conditions have been developed, including low pour point diesel fuel, subzero engine oil, automobile and artillery grease, and combat automobile gasoline.

b. Methods of Distribution. Gasoline is distributed by pipeline, barge, surface vehicles, and air transport. The use of ahkios and sleds is often necessary in winter to supplement wheeled and tracked vehicles.

c. Phasing Seasonal Supplies. Seasonal supplies of petroleum should be phased to arrive as needed. This will decrease storage and transportation problems, double handling, and loss of manpower.

d. Coordination. Close coordination with supporting supply sources is necessary to meet the petroleum needs of a division under Arctic conditions.

e. Distribution System. The distribution system for class III items in the Arctic and subarctic is similar to that in temperate areas, but the methods of operating the system are modified as in *b* above.

f. Liquid Fuels for Heating. Liquid fuels, including diesel oil, are class III items supplied by the Quartermaster Corps through normal distribution channels of a division. The fuels are used to operate tent heaters and other equipment in the Arctic.

Section II. TROPICS

10. Site Selection

Sites for quartermaster units in the tropics should be—

- a. Located near a waterway and adjacent to a road.
- b. On high, dry, open, and level ground.
- c. Near a source of fresh water.
- d. Away from native villages that may constitute sanitary hazards and contain hostile inhabitants.

11. Estimating Supply Requirements

Supply requirements in the tropics differ from those in temperate climates and estimates are affected by the following factors:

- a. Rapid deterioration of supplies because of excessive heat, dampness, and sunlight.
- b. At times, trails must be hacked through jungles, or rains may bog down land movements and a longer delivery time results.
- c. Requirements must be anticipated and requisitions submitted well in advance of needs.
- d. Supply must be geared to the needs of small units operating in isolated locations. Unit operations by large bodies of troops is unusual in jungle warfare.

12. Transporting Supplies

a. *Reconnaissance.* Movement of supplies in the tropics requires continuous reconnaissance of supply routes. Where possible, alternate routes will be selected.

b. Water Transportation. Water transportation is a basic method in the tropics. Streams may be used as trails. Small boats give relatively fast and dependable movement.

c. Land Transportation.

- (1) Most transportation by land is hand-carry. Non-United States personnel may be used but require close supervision.
- (2) Pack mules may be used. Mules must pack their own food and thereby decrease their capacity to carry other supplies.
- (3) Wheeled vehicles may be used in dry seasons on roads and on trails where jungle growth is light.
- (4) Track-laying vehicles are generally reliable in tropical operations but offer serious maintenance and supply problems.

d. Air Transportation. Isolated parties and small units can often be more easily supplied by aircraft than by surface transportation.

13. Storing Supplies

a. Protection. All supplies must be protected from spoilage, rust, and rot by tentage, paulins, or covered storage.

b. Security. Measures should be taken to protect supplies from theft and from raids by guerillas and saboteurs.

14. Class I Supply Operations

Nonperishable canned and dehydrated foods are most practical for jungle rations. They are easily

transported under difficult conditions. Hot meals are served whenever possible. Class I distributing points usually operate in daylight because of the danger and difficulty of movement at night and the possibility of enemy night attacks.

15. Class II and IV Supply Operations

a. Class II. Replacement of clothing, particularly shoes and socks, is a primary consideration in class II supply operations. The need for articles of this type must be estimated well in advance and special provision made for resupply.

b. Class IV. Special items of individual or unit equipment are included in class IV supply for jungle areas. Certain items not authorized under temperate climate conditions will become available to units assigned to operate in the jungle.

16. Class III Supply Operations

Since relatively few vehicles are used in jungle operations, the supply of class III items is more limited than in temperate climates. Battalions and groups draw their supply from the division class III distributing point and establish class III breakdown points for operating vehicles.

17. Bath Operations

Bath operations in jungle areas require a cleared site near abundant clean water. Usually, bathing is in the open by daylight, but tents may be required in inclement weather.

INDEX

	Paragraphs	Page
Acquisition of class I reserves.....	31	48
Adjusting breakdown allotments.....	35	55
Aerial delivery.....	17, 90	38, 114
Ammunition.....	17-73	102
Apportioning bulk class I supplies.....	44-46	64
Armored division:		
Combat organization.....	9	16
Logistical organization.....	10	17
Armored division quartermaster battalion	11	18
Airborne quartermaster parachute supply company.....	16	34
Airborne supply and transportation company.....	15	30
Bath facilities and operation.....	74-76	103
Bulk distribution.....	60	90
Captured materiel.....	89	113
Class I supply:		
Administration.....	29-49	47
Authorized reserve.....	31	48
Breakdown and issue.....	47-49	66
Characteristics.....	28	47
Distribution in infantry and armored divisions.....	42	62
Class II and IV supply:		
Characteristics.....	51	73
Controls.....	52	75
Distribution.....	56-58	88
Regulated items.....	54	78
Requirements.....	51	73
Requisitioning.....	53-55	77

	Paragraphs	Page
Class III supply:		
Armored division-----	67	97
Characteristics -----	59, 60	90
Distributing point-----	69, 70	98
Infantry division-----	66	95
Requisition -----	64	92
Requirements -----	61	91
Clothing exchange-----	76	104
Command-controlled items-----	52	75
Daily ration request-----	37	57
Distributing points-----	21, 22	43
Division collecting point:		
Recovery and disposition-----	78, 80	106, 108
Salvage -----	87	111
Division logistics control center (DLCC)-----	10, 14	17, 28
Division quartermaster:		
Armored division-----	11	18
Infantry division-----	6	6
Emergency medical tag-----	82	109
Exchange officer-----	6	6
Food adviser-----	92	116
Food service-----	92	116
Forms -----	3	4
Graves registration-----	77-86	105
Identification -----	85	110
Infantry division:		
Combat organization-----	5	5
Logistical organization-----	6	6
Infantry division quartermaster company-----	6	6
Item pile breakdown-----	49	66
Laundry service-----	91	115
Local procurement-----	20	41
Maintenance -----	88	112
Personal effects-----	84	110
Post exchange facilities-----	6	6
Purpose -----	1	3

	Paragraphs	Page
Ration:		
Augmentation -----	30	48
Cycle -----	36	55
Recovery and disposition -----	77-86	105
Regulated items -----	54	78
Remains, caring for -----	81	109
Repair parts -----	54	78
Request for issue and turn-in -----	54	78
Requisitioning procedure:		
Class I -----	40	59
Class II and IV -----	53-55	77
Class III -----	64-65	92
Class V -----	71-73	102
Reserves:		
Class I -----	31	48
Class II and IB -----	57	89
Salvage -----	87	111
Scheduling ration breakdown and delivery -----	36	55
Scope of manual -----	1	3
Security:		
Communications -----	24	45
Defense against CBR and nuclear attack -----	27	46
Measures -----	25	46
Training -----	26	46
Selective stockage -----	52	75
Supply:		
Principles -----	17	38
Procurement -----	20	41
Requirements -----	19	40
Responsibility -----	18	40
Truck-to-truck issue, class I -----	47	66
Unit:		
Estimates, class III -----	61	91
Pile breakdown method, class I -----	49	66
Ration breakdown sheet -----	34	50

By Order of *Wilber M. Brucker*, Secretary of the

Army:

MAXWELL D. TAYLOR,
General, United States Army,
Chief of Staff.

Official:

HERBERT M. JONES,
Major General, United States Army,
The Adjutant General.

[AG 321 (29 Aug 58)]

Distribution:

Active Army:

DCSPER (2)	ICAP (5)
ACSI (2)	Br Svc Sch (5) except
DCSOPS (5)	USA QM Sch (200)
DCSLOG (5)	PMSTSr Div Unit (1)
Technical Stf, DA (5) ex-	PMST Jr Div Unit (1)
cept TQMG (25)	PMST Mil Sch Div Unit (1)
Technical Stf Bd (2)	Gen Depot (1)
USCONARC (5)	QM Sec, Gen Depot (2)
US ARADCOM (Incl ea	QM Depot (5)
Rgn Comd) (2)	USATC (2)
OS Maj Comd (10)	Units org under fol TOE:
OS Base Comd (2)	10-17 (5)
Log Comd (5)	10-46 (5)
MDW (5)	10-47 (5)
Armies (10)	10-48 (5)
Corps (10)	10-157 (2)
Div (Incl ea Eng Div)	10-167 (2)
(10)	10-187 (2)
Brig (2)	10-197 (2)
Regt/Gp/bg (5)	10-227 (2)
Class I Instl (2)	10-237 (2)
USMA (10)	10-297 (2)
Svc Colleges (5)	29-51 (2)
NWC (5)	29-57 (2)
AFSC (5)	

NG: State AG (3); units—same as Active Army except allowance is one copy to each unit.

USAR: Units—same as Active Army except allowance is one copy to each unit.

For explanation of abbreviations used, see AR 320-50.